



Advanced Set

Elektronik Experimentierkasten

Kreativität fördern - Entwicklung stärken

Electronics experiments box

Promote creativity - strengthen development

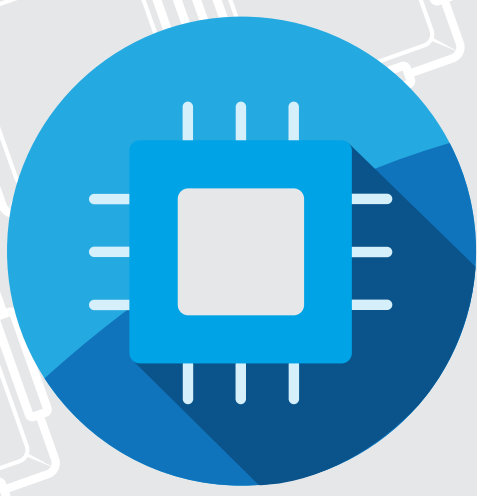

1.	Table of contents	3
2.	Safety information	6
3.	Bricks (components) of the advanced sets	7
	3.1 Connectors	8
	3.2 Basic bricks	9
	3.3 Resistors	11
	3.4 Capacitors	13
	3.5 Inductors/coils	16
	3.6 Diodes and optoelements	17
	3.7 Antennas & audio elements	21
	3.8 Switches and transistors	22
	3.9 Amplifier	24
	3.10 Special modules	
4.	Experimental setup - circuits	25
	4.1 LED lights	
	4.2 Open circuit	26
	4.3 Two LEDs - parallel circuit	27
	4.4 Battery polarity - measuring	28
	4.5 Ground and brick	29
	4.6 Simplified circuit with ground-brick	31
	4.7 Circuit with push button	32
	4.8 Circuit with switch	33
5.	Digital logic with buttons	34
	5.1 AND circuit	
	5.2 OR circuit	35
	5.3 NOT circuit	36
	5.4 Exclusive OR circuit	37
6.	The resistor	38
	6.1 Calculation of the resistance value	
	6.2 LDR - light dependent resistor	39
	6.3 The parallel circuit	40
	6.4 Series circuit	41
	6.5 The potentiometer	42
	6.6 Threshold voltage	43
7.	Capacitor	44
	7.1 Charging and discharging	
	7.2 Capacitor with 10 μ F	45
	7.3 Recharge capacitor	46
8.	Inductance	47
	8.1 Charging and discharging a coil	
	8.2 Induction	48
	8.3 Inductive voltage	49
	8.4 Energy harvesting	50
9.	Transistors	51
	9.1 Transistors as switch	
	9.2 Transistors in darlington configuration used as touch sensor	52
	9.3 Darlington circuit with capacitive touch sensor	53
	9.4 LDR and transistor	54
	9.5 LDR used for night light with transistor and resistor	55

9.6	LED as photo diode	56
9.7	Transistor as inverter	57
9.8	LED inverted	58
9.9	LED with constant current at 9V supply voltage	59
9.10	LED with constant current at 18V supply voltage	60
9.11	Astable multivibrator	61
9.12	Monostable multivibrator	62
9.13	Bistable multivibrator	63
10.	JFET (Junction Field Effect Transistor)	64
10.1	J310-n-channel JFET	
11.	MOSFET	65
11.1	MOSFET basics	
11.2	MOSFET as switch	66
11.3	Simple NMOS touch sensor	67
12.	Special semiconductors	68
12.1	PUT - Programmable Unijunction Transistor	
12.2	Thyristor in the equivalent circuit diagram	69
13.	Timer 555	70
13.1	Timer astable	
13.2	Timer monostable	71
13.3	Timer bistable	72
13.4	Timer 555 bistable alternative 1	73
13.5	Timer 555 bistable alternative 2	74
13.6	Timer 555 as voltage generator	75
14.	Logic circuits	76
14.1	AND with diodes	
14.2	OR with diodes	77
14.3	NAND-circuit with transistors	78
14.4	NOR-circuit	79
14.5	AND-circuit	80
14.6	OR-circuit	81
15.	Oscillators	82
15.1	RF oscillator 13.56 MHz ISM Band	
15.2	Crystal oscillator with tuning	83
15.3	Crystal oscillator with capacitance diode for tuning	84
15.4	Oscillator resonant circuit with capacitor and coil	85
16.	Operation amplifier	86
16.1	OPAMP basics	
16.2	OPAMP as voltage follower	87
16.3	OPAMP as non inverting 11:1 amp	88
16.4	OPAMP as an inverting 10:1 amp with virtual ground	89
16.5	OPAMP as integrator	90
16.6	OPAMP as a differentiator	91
16.7	OPAMP as oscillator with coil and capacitor	92
16.8	Wien-Robinson-Oscillator	93
16.9	Wien-Robinson-Oscillator with stabilisation	94

17.	Audio amplifier with LM386	95
17.1	Microphone and amplifier	
17.2	Noise generator	96
17.3	Noise generator 2	97
17.4	Light amplifier	98
17.5	OPAMP as AC power line detector	99
17.6	Light barrier for audio transmission	100
17.7	Photo transistor with preamp	101
17.8	Photo transistor with infrared (IR) transmission	102
17.9	Photo diode for IR transmission	103
18.	Relay circuits	104
18.1	Relay	
18.2	The relay as switch	105
18.3	Relay in series	106
18.4	Relay in series	107
18.5	Relay in parallel circuit	108
18.6	Relay in self-sustaining	109
18.7	Relay in self-sustaining with interrupter	110
18.8	Relay with self-interrupter	111
18.9	Relay with self-interrupting second relay	112
18.10	Slowly self-sustaining relay	113
18.11	Relay (NOT operation)	114
18.12	Relay (AND operation)	115
18.13	Relay (NOT AND (NAND) operation)	116
18.14	Relay OR operation	117
18.15	Relay NOT OR (NOR) operation	118
18.16	Relay Exclusiv-OR (XOR) operation	119
19.	Reed Relay	120
19.1	Reed Relay	
20.	Buzzer Morse circuit	121
21.	Alarm systems	122
21.1	Alarm system 1	
21.2	Alarm system 2	123
21.3	Alarm system 3	124
21.4	Light barrier 1	125
21.5	Light barrier 2	126
22.	Thermo elements	127
22.1	Thermo elements with PTC	
22.2	Thermo elements with NTC	128
22.3	NTC with MOSFET (n-channel, enhancement mode)	129
22.4	NTC with Bipolar transistor (BC817)	130
23.	A look into the future	131

2. Safety information

Note: Never connect the bricks directly to the mains power supply (115V/230V). There might be danger to life.

Please only use the included power supply-bricks. The voltage of our power-supply modules is 9V, which is not a health hazard. Please also ensure, that no openly wires are in contact with the mains power outlets. Otherwise there might be a danger of hazardous electric shocks. Never look straight into LEDs, since this may damage your eye retina

Please connect the included polarized capacitors (tantalum/electrolytic) only with the positive side to the plus side of the power supply. If those polarized capacitors are connected not correctly, they can be destroyed and even explode!

Please remove the power supply brick everytime you finished expimenting, to avoid the risk af an electric fire.



3. Bricks (components) of the advanced set

The bricks are compact modules for the electronic world. They are a perfect solution for young scientists to get used to the world of electronics. The sets contains standard components like connectors, power supplies as well as active and passive bricks. The following list gives an overview with the entities of the most common properties and the abbreviations.

Value	Entity	Symbol/abbreviation
Current	Ampere	A
Voltage	Volt	V
power	Watt	W
Resistance	Ohm	Ω
Capacitance value (Capacitor)	Farad	F
Inductance value (Coil)	Henry	H
Frequency	Hertz	Hz
Prefix for $\times 10^3$	Kilo	k
Prefix for $\times 10^6$	Mega	M
Prefix for $\times 10^9$	Giga	G
Prefix for $\times 10^{12}$	Tera	T
Prefix for $\times 10^{-3}$	Milli	m
Prefix for $\times 10^{-6}$	Micro	μ
Prefix for $\times 10^{-9}$	Nano	n
Prefix for $\times 10^{-12}$	Pico	p
Prefix for $\times 10^{-15}$	Femto	f

3.1 Connectors

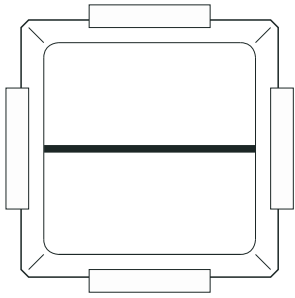

The line brick connects two bricks.
This is necessary for closing gaps in complicated circuits.

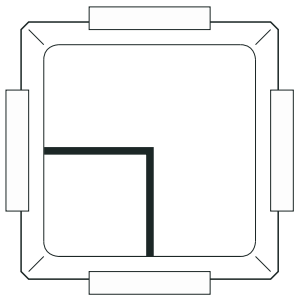

The corner-brick connects two bricks with a 90° angle.

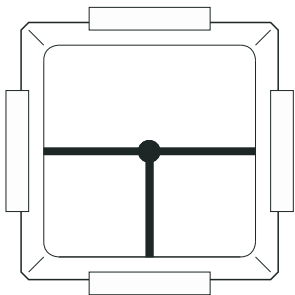

The T-brick is perfect for building junctions.

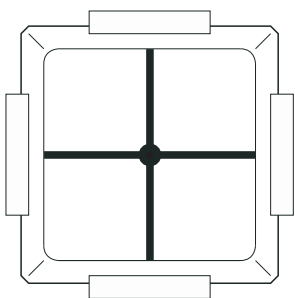

The cross-brick allows connecting four sides. At the corner of the circuit the cross-bridge can be used in-line or as a corner-brick.

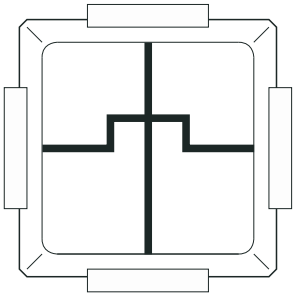

Unlike the cross-brick, the double straight-brick connects only the opposite sides, bottom, top and left to right.

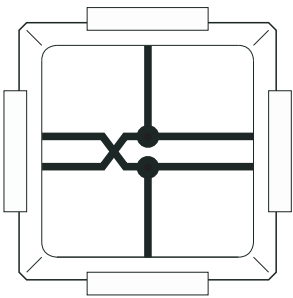

This brick connects the separate center contacts. By separating and crossing the lines, the connection can be changed.

3.2 Basic bricks

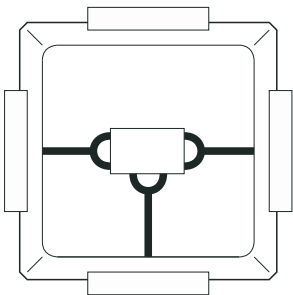

The universal-brick can be used to integrate external components in a circuit. For example it can be used for integrating 9.8k Ω resistors. It can also be used like a switch, for closing junctions in a circuit.

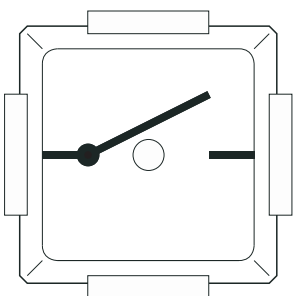

The push-button-brick is an electromechanical switch, that allows a conductive connection only during pressing and holding the button. At the moment of release the connection will open again and the button returns to its initial position.

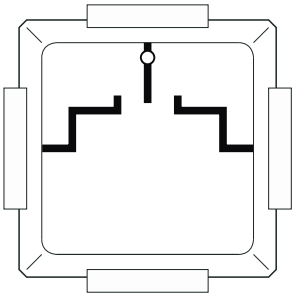

The switch-brick combines either the right or the left-hand contact with the middle one. In center position all connections are separated. The maximum current flow is 6A.

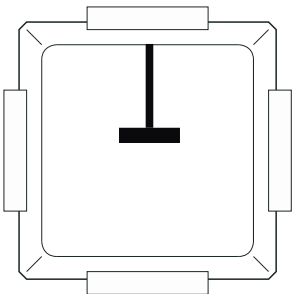

The ground-brick close a circuit. This allows a much easier usage and saves the number of bricks needed to complete a circuit. The ground-brick connects the two center contacts with the two outer contacts used as ground connection.

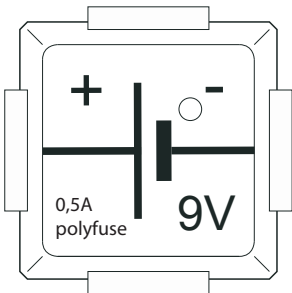

The battery power-supply-brick should be inserted as last component. Please check the circuit before connecting the power supply to avoid a risk of a short-circuit. The battery-brick uses 9V to supply the circuit. The integrated LED gives an optical feedback and informs the user with a red LED light in case of a short-circuit.

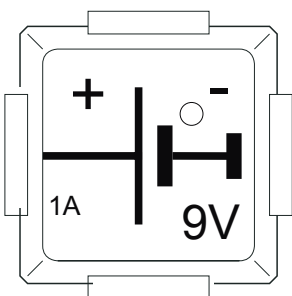

The power-supply-brick is the second way to power a circuit. It provides a stabilized DC voltage of 9V with a maximum short-circuit-proof current flow of 1A. The ground is connected to the minus pole, so that no further ground-bricks must be used to complete the circuit. A green LED signals the correct insertion of the brick. To reduce the risk of electronic malfunctions the power-supply-brick should be disconnected after an experiment.

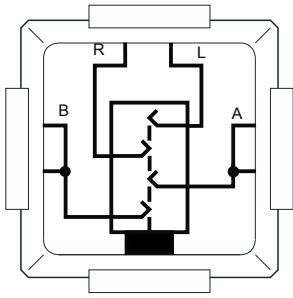

This Brick contains four 3.5mm stereo jacks or microphone connections. Each socket has a four-pin connector, which is suitable for a combination of headphone and microphone.

3.3 Resistors

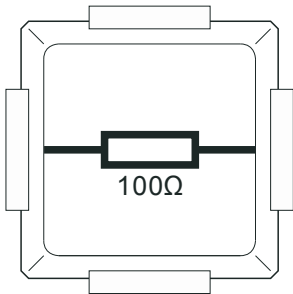

This brick has an electrical resistance of 100Ω . This value corresponds to a current flow of 10mA at a voltage of 1V . As all our resistors, the resulting power dissipation should not exceed 0.125 watt.

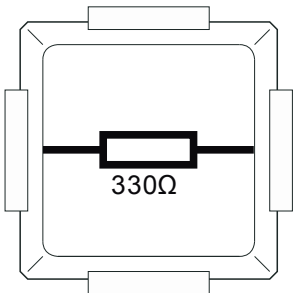

This brick has an electrical resistance of 330Ω . This value corresponds to a current flow of 3.03mA at a voltage of 1V . As all our resistors, the resulting power dissipation should not exceed 0.125 watt.

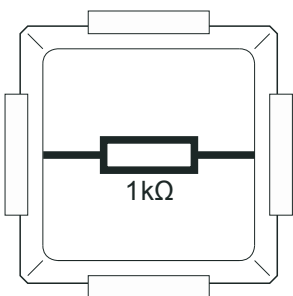

This brick has an electrical resistance of $1\text{k}\Omega$. This value corresponds to a current flow of 1mA at a voltage of 1V . As all our resistors, the resulting power dissipation should not exceed 0.125 watt.

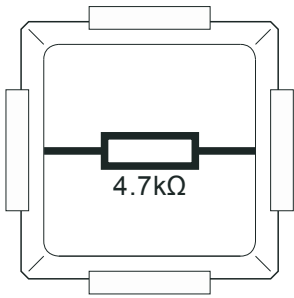

This brick has an electrical resistance of $4.7\text{k}\Omega$. This value corresponds to a current flow of $213\mu\text{A}$ at a voltage of 1V . As all our resistors, the resulting power dissipation should not exceed 0.125 watt.

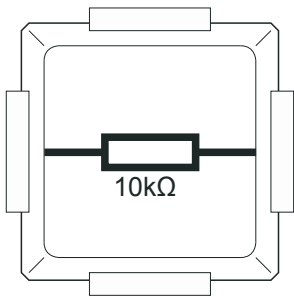

This brick has an electrical resistance of $10\text{k}\Omega$. This value corresponds to a current flow of $100\mu\text{A}$ at a voltage of 1V . As all our resistors, the resulting power dissipation should not exceed 0.125 watt.

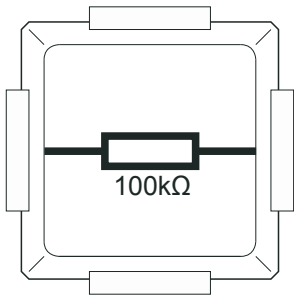

This brick has an electrical resistance of $100\text{k}\Omega$. This value corresponds to a current flow of $10\mu\text{A}$ at a voltage of 1V . As all our resistors, the resulting power dissipation should not exceed 0.125 watt.

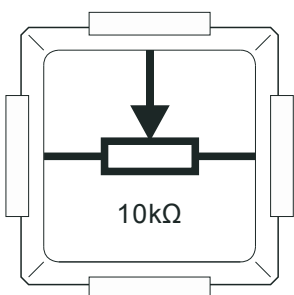

The potentiometer is a manually variable resistor. The third contact (wiper) changes the amount of electrical resistance by moving it from left to right. Can be adjusted in the range of 0 to $10\text{k}\Omega$. If the wiper or one of the other contacts is connected directly to the power supply, a short circuit will appear. This must be avoided! The potentiometer has a maximum power of approximately 0.125 watt.

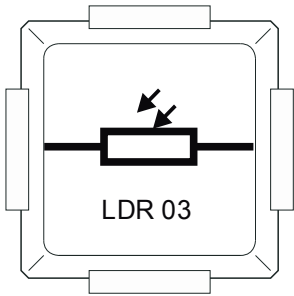

The LDR 03 is a light-dependent resistor. The more light falls on the sensor, the smaller the resistance will be. The values vary from a few 100Ω in bright environment and several kilo Ohm in the dark. The change of the resistance value is continuous.

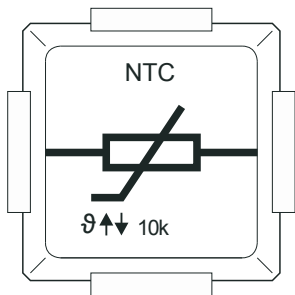

A NTC-resistor (Negative-Temperature-Coefficient) follows the temperature change with a positive gradient. For example if the temperature increases, the electrical resistance decreases. The resistance value as on the circuit symbol is $10k$ at standard 25°C room temperature. The NTC resistor is well suited as a temperature sensor.

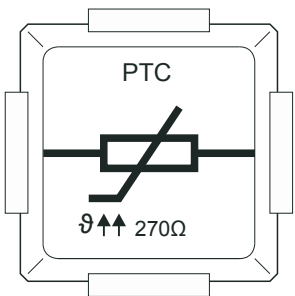

The PTC-resistor (Positive-Temperature-Coefficient), follows the temperature change with a positive gradient. For example, the temperature rises, the electrical resistance also increases. The resistance value as on the circuit symbol is 270Ω at common room temperature. The PTC is perfect for a temperature range from -10°C to $+40^\circ\text{C}$, because this range offers a very sensitive resistance change according to the temperature changes.

Attention: The nominal value of the PTC might be different in the set than printed here as an example!

3.4 Capacitors

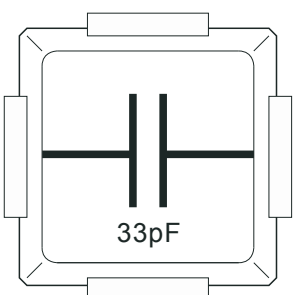

The set includes a capacitor with a capacity of 33pF . It can store electrical energy and releases it very quickly like a rubber band does by using mechanical energy. 1F means that a voltage of 1V is achieved when charged for 1s by a current of 1A . Capacitors usually have a very low capacity. Capacitors must not exceed the specific maximum voltage.

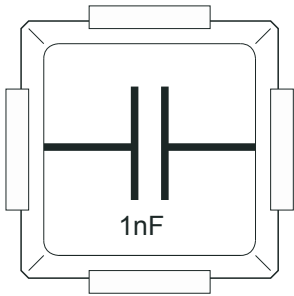

The set includes a capacitor with a capacity of 1nF. The charging voltage of 1V is achieved already after 1ns, when loaded with a current of 1A. Capacitors must not exceed their specific maximum voltage.

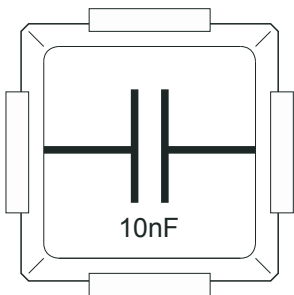

This capacitor has a capacitance of 10nF. Therefore it can store 10 times more electricity than the 1nF variant. A charging voltage of 1V is achieved already after 1ns, when loaded with a current of 1A 10nF. Capacitors must not exceed their specific maximum voltage.

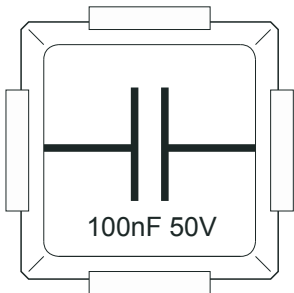

This capacitor has a capacitance of 100nF. Therefore it can store up to 100 times more electricity than the 1nF version. The charging voltage of 1V is reached after 100ns, when charged with a current of 1A. Capacitors must not exceed their specific maximum voltage of 50V.

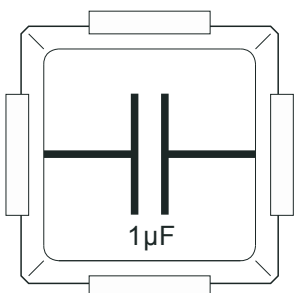

This capacitor has a capacitance of 1µF. Therefore it can save 1,000 times more electricity than the 1nF version. The charging voltage of 1V is reached after 1µs, when charged with a current of 1A. Capacitors must not exceed their specific maximum voltage of 50V.

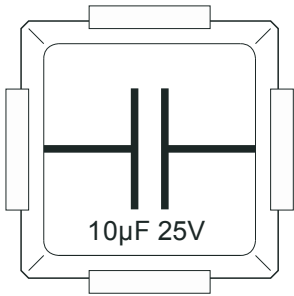

This capacitor has a capacitance of 10µF. Therefore it can store 10,000 times more electricity than the 1nF variant. A charging voltage of 1V is achieved already after 10µs, when loaded with a current of 1A. Capacitors must not exceed their specific maximum voltage.

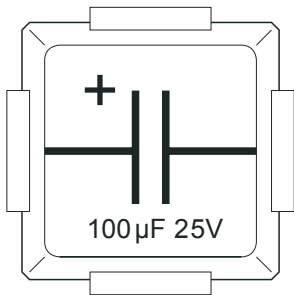

This capacitor has a capacitance of 100µF and can be used with a maximum voltage of 25V. This electrolytic capacitor should only be connected (directly or indirectly) to the positive port of the 9V power-supply. It can store 100,000 times more electricity than the 1nF variant. A charging voltage of 1V is achieved already after 100µs, when loaded with a current of 1A. Capacitors must not exceed their specific maximum voltage.

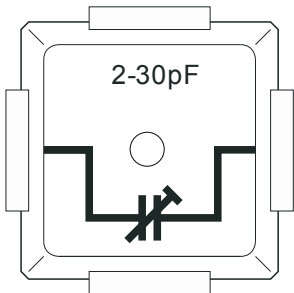

The trimmer-brick includes a capacitor with a capacitance value of 2pF to 30pF. The value can be adjusted manually by turning the knob. This brick can be easily used for tuning resonant or filter circuits.

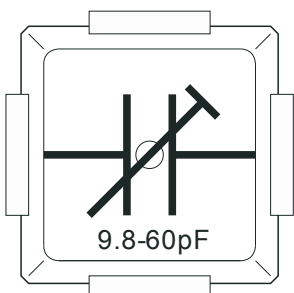

The trimmer has an adjustment range from 9.8pF to 60pF. The capacitance value can be increased by turning the knob clockwise. This brick can be easily used for tuning resonant or filter circuits.

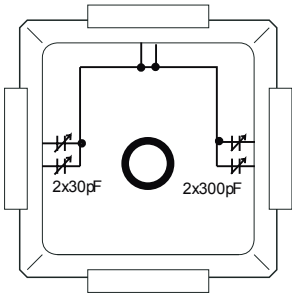

This trimmer-brick has four variable capacitors installed. They are connected separately to the brick contacts two with 2x 30pF and two with 2x 300pF. The value of both together can be adjusted by turning the knob. With different connection bricks its possible to combine the different capacitor ranges to a total adjustable capacity.

3.5 Inductors / coils

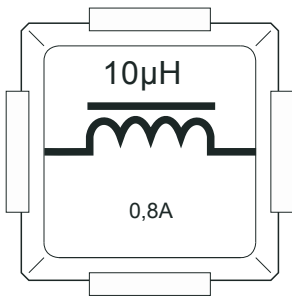

This brick contains a coil with an inductance of 10µH. An induction voltage of 1V is achieved at 10µs, by a current flow change of 1A. Coils can be used for setting up frequency resonant circuits and filters. Coils counteract any changes in current flow to stabilize the circuit.

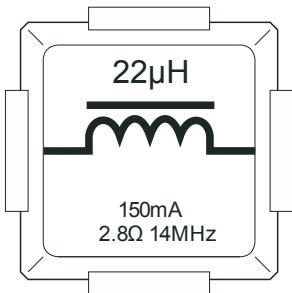

This brick contains a coil with an inductance of 22µH. An induction voltage of 1V is achieved at 22µs, by a current flow change of 1A. Coils can be used for setting up frequency resonant circuits and filters. Coils counteract any changes in current flow to stabilize the circuit. This current-stabilizing property is used for converting (transforming) a voltage.

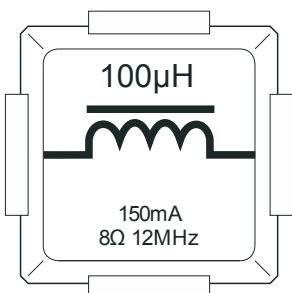

This brick contains a coil with an inductance of 100µH. An induction voltage of 1V is achieved at 0.1ms, by a current flow change of 1A. Coils can be used for setting up frequency resonant circuits and filters. Coils counteract any changes in current flow to stabilize the circuit. This current-stabilizing property is used for converting (transforming) a voltage.

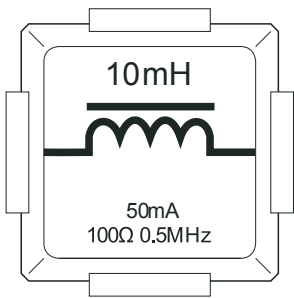

This brick contains a coil with an inductance of 10mH. An induction voltage of 1V is achieved at 10ms, by a current flow change of 1A. Coils can be used for setting up frequency resonant circuits and filters. Coils counteract to any current change.

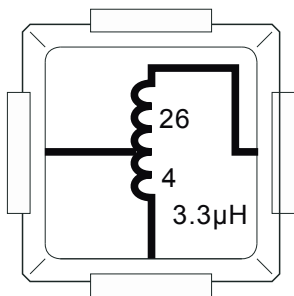

The advanced set contains a coils with an inductance of 3.3µH. Inductances occur only when the current flow changes. At a constant voltage a coils acts like a resistor. An inductance of 1H indicates that, for a change of current flow of 1A within one second, a voltage of 1V is induced. This coil achieves an inductive voltage of 1A at 3.3µs at a current change of 1A. The tap is used to achieve partial inductances of the total value.

3.6 Diodes and optoelements

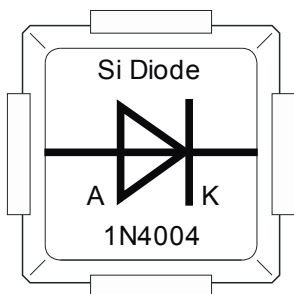

This brick includes a power diode. Its special property is high reverse voltage rating of around 400V. It also works like a normal diode. The forward voltage is around 0.7-1V.

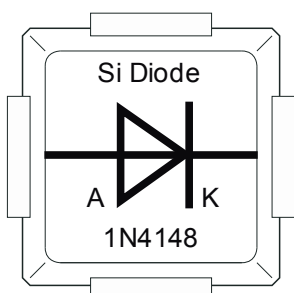

The special feature of this diode is that it can rectify voltages up to 100V and can also switch very high frequencies of up to 100MHz. It is operated in forward direction. In reverse direction the current flow is very low.

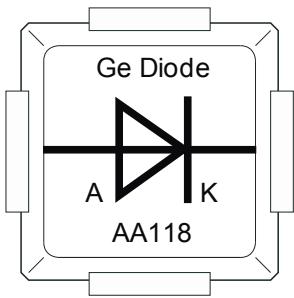

A germanium diode allows, as well as all other diodes, only a current flow in forward direction. Its uniqueness lies in the used semiconductor material germanium. This allows a substantially lower diffusion voltage compared to silicon material. The diffusion voltage of this diode-brick is only 0.2V. The AA118 can be used for application with frequencies up to 1 GHz.

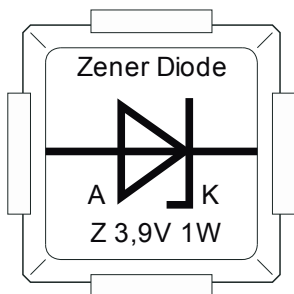

This brick contains a zener diode. It has the particular property to stabilize the voltage. The voltage stabilization takes place in the reverse direction on this component. If the voltage is large enough a break down occurs and current flows in the reverse direction. The break down voltage is also called zener voltage and this brick has a break down voltage of 3.9V.

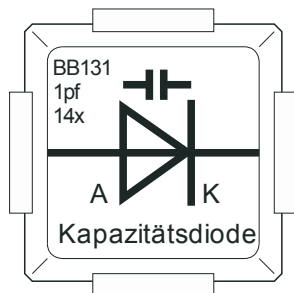

This brick contains a capacitance diode. When operated in reverse direction it has a controllable capacity. If a voltage is applied in the reverse direction, an isolated zone is formed between the conductive layers of the diode. This zone increases the block voltage and the capacity decreases. Thus allows controlling oscillations in electric circuits.

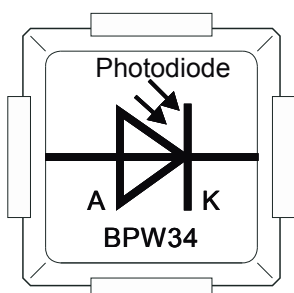

This brick is a photodiode. Please pay attention to the polarity. A photodiode conducts electricity, like all other diodes, only in forward direction. To use it as a light sensor, the brick must be inserted in reverse direction. In this case they become conductive when exposed to light. For this purpose the anode must be connected to the negative terminal of the voltage source and the cathode to its positive terminal.

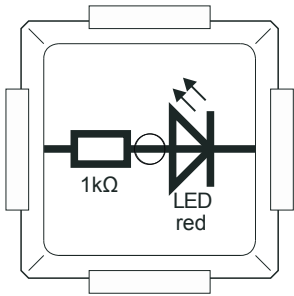

This LED-brick has a red LED with a series resistance of $1k\Omega$ installed. It can be operated in forward direction. Installed correctly (in forward direction) the LED lights up, when a minimum voltage of approx. 1.5V is reached. The minimum voltage depends of the colour of the LED.

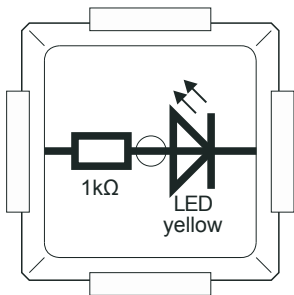

This LED-brick has a yellow LED with a series resistance of $1k\Omega$ installed. It can be operated in forward direction. Installed correctly (in forward direction) the LED lights up, when a minimum voltage of approx. 1.7V is reached. The minimum voltage depends of the colour of the LED.

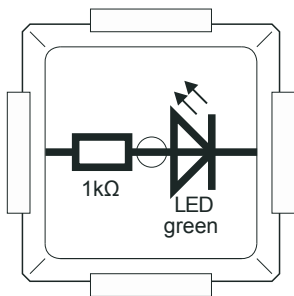

This LED-brick has a green LED with a series resistance of $1k\Omega$ installed. It can be operated in forward direction. Installed correctly (in forward direction) the LED lights up, when a minimum voltage of approx. 1.8V is reached. The minimum voltage depends of the colour of the LED.

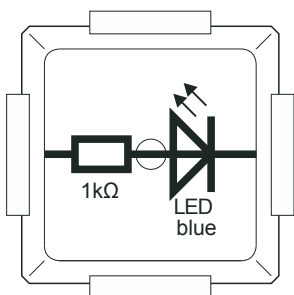

This LED-brick has a blue LED with a series resistance of $1k\Omega$ installed. It can be operated in forward direction. Installed correctly (in forward direction) the LED lights up, when a minimum voltage of approx. 2.7V is reached. The minimum voltage depends of the colour of the LED.

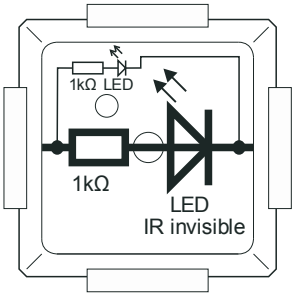

This brick contains an infrared diode. The human eye can no longer detect the wavelength of the emitted light, as it is below (Latin: infra) the visible range (400nm-700nm) with about 780nm. A red LED indicates activity. Caution: Invisible radiation.

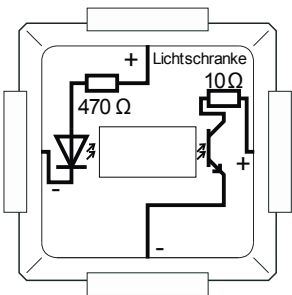

This brick contains a photoelectric barrier. The operation is based on the fact that a LED illuminates a phototransistor. When the optical connection between the LED and the phototransistor is interrupted, the transistor is in cutoff. Light barriers for example are used in alarm systems or as incremental sensors in industry applications. All information is transmitted fully isolated without any electrical contact. This can be used as galvanic isolation.

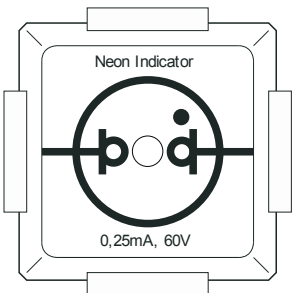

The glow lamp belongs, such as fluorescent lamps to the group of gas discharge lamps. A high voltage of about 70V is applied, resulting in the ionization of the inert gas atoms in the inside of the lamp. This process is called impact ionization. Inert gases are used in the lamp to prevent a further reaction of the atoms. The luminous phenomenon is always observed at the cathode. When AC voltage is applied, both electrodes illuminate.

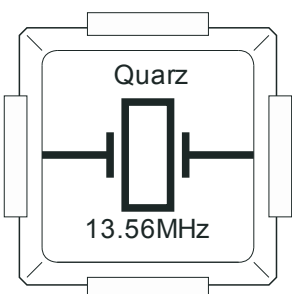

A crystal oscillator generates an accurate vibration by an externally applied alternating field. It can be integrated in a series or parallel circuit. Each crystal resonator has a natural or resonance frequency. The brick contains a crystal that oscillates at 13.56 MHz. The quality of the generated oscillation is very high.

3.7 Antennas & audio elements

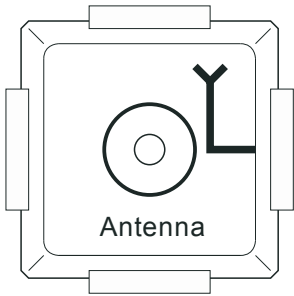

An antenna receives or transmits electromagnetic waves.

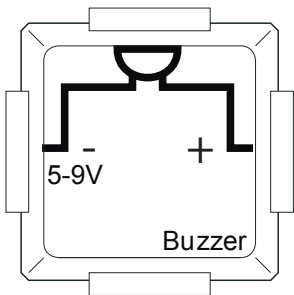

The buzzer converts electrical signals into acoustic. However, it does not have a broad frequency spectrum, such as a speaker. The generation of different sound signals is not possible. Its intended for short, simple acoustic messages. The buzzer is built with a piezoelectric element or an electromagnet and is operated with an AC voltage. Our brick contains an electronic circuit, therefore you have to note the polarity (+, -), a DC voltage, because its internally transformed

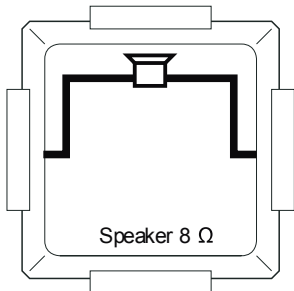

The speaker converts electrical signals into tones. Speakers are designed for a specific frequency range, depending on the specific tasks. A broadband speaker, for example has a spectrum of 40 - 20,000Hz. Speakers may only be operated with an appropriate power and the correct resistance value. The following formula applies to our speaker: $\sqrt{(P \cdot R)} = V$, $\sqrt{(0.25W \cdot 8\Omega)} = 2V$. Therefore our speaker-brick must not be connected to the 9V power-supply.

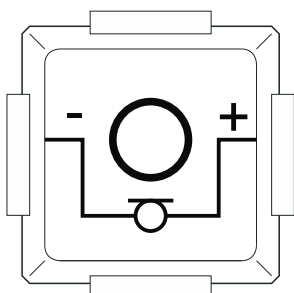

Our microphone-brick converts acoustic waves into electrical signals. The microphone can be described as the opposite of the speaker. Many microphones make use of a variable capacitance value, to convert the pressure waves of the sound into an electrical signal. As our microphone contains a field effect transistor for amplification, its important to pay attention to the correct polarity (+/-). The frequency range extends from 20 - 20,000Hz, the sensitivity is about $5-10 \frac{mV}{Pa}$

3.8 Switches and transistors

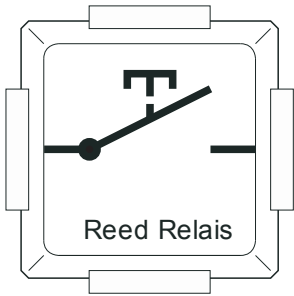

A reed contact switch (thin tube) is activated by an by the outside magnetic field. This magnetic field can be generated by a permanent magnet or electromagnet. Reed switches have a low remanent magnetization. They turn on whenever an external magnetic field is added in the same direction and turn off when the external magnetic field is removed. They are used as a proximity switch.

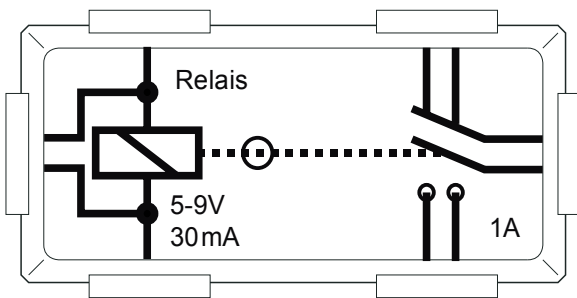

The relais-brick is an electromagnetic switch. The control circuit and the contacts are electrically isolated. The minimum voltage is approx. 5V at a current flow of 30mA. A relay can switch substantially larger currents as needed for triggering. Our relays can switch up to 1A. Our relay-brick has a build-in rectifier and stabilizator, so that the relay can operate up to 9V, without taking care of the polarity. An LED indicates, when the relay is activated.

Attention:

Transistors can be destroyed when voltage is applied without a resistor between terminals B (base) and E (emitter), or the terminals C (collector) and E! Transistors are electronic switches not operating like a manual light switch, but by a current flow into its B port. The switched current flow between the C- and E-Contact must not exceed 0.8A otherwise the transistor may be destroyed. For an NPN transistor the base should be positive in relation to the emitter for normal operation.

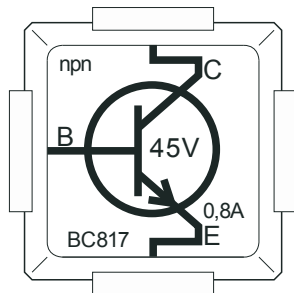

This brick contains an npn transistor. It controls the flow of current between the collector (C) and emitter (E) via the much smaller current flow at its base contact (B). The base should be positive in relation to the emitter for normal operation.

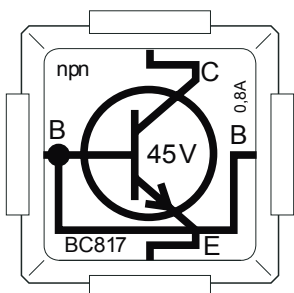

This brick contains the same npn transistor. It controls the flow of the current between the collector (C) and Emitter (E) via its smaller current flow into its base contact (B). The base should be positive in relation to the emitter for normal operation. In addition this brick offers a connection of the base to the left side and to the right side. This allows a much easier construction of complex circuits.

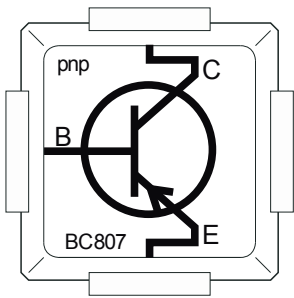

The PNP transistor controls with a much smaller current flow into the base contacts (B) the much higher current flow between Emitter (E) and Collector (C). For normal operation the base needs to be negative in relation to the emitter.

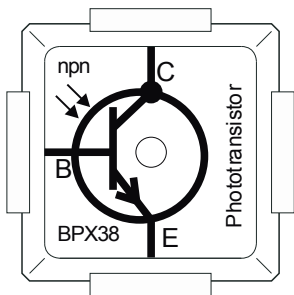

The phototransistor controls the collector-emitter-current through the current into the base, like a conventional transistor. In addition the current flows from collector to emitter can also be controlled by light emitted into the transparent opening into the transistor. The phototransistor is somehow similar to a photoresistor, but the gain of the transistor makes it more sensitive.

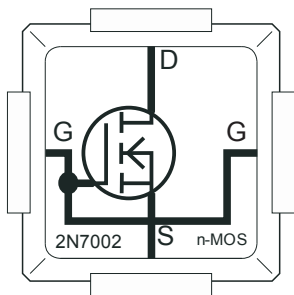

Our field effect transistor controls the current flow between drain and source via the voltage applied at the gate. The special thing about this device is that the connection between the gate and source is very high impedance. Field effect transistors are also called MOSFET (Metal Oxid Semi-channel Field Effect Transistor) or referred to as "MOS". There are different types of MOS, our brick is a enhancement type n channel which is normally in off condition. This means that a positive voltage above a certain threshold voltage needs to be applied to the gate, so the MOS begins conduct between drain and source.

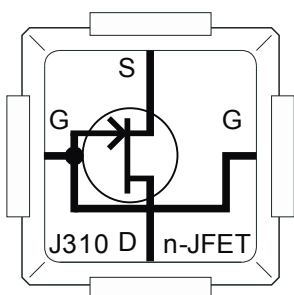

A JFET (Junction Field Effect Transistor) is conducting from source to drain without an external voltage at the gate. It behaves like a standard resistor until the cut off voltage is reached. This is approx. at 2.5 volts. The current flow between drain and source remains constant when the cutt off level is reached. This cutoff voltage can be reduced by a negativ voltage in relation to the source contact. This negative voltage also controls the overall current flow.

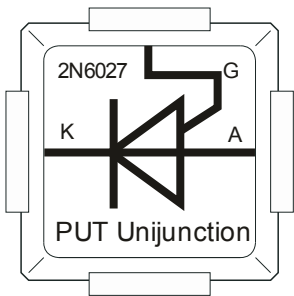

This brick contains a PUT (Programmable Unijunction Transistor). The special thing about this device is the adjustable threshold voltage between anode and cathode. When a voltage is applied in forward direction, the resistance between anode and cathode to reach the threshold is very high. After applying a positive voltage to the gate, the threshold voltage can be reduced and the PUT gets low conductive much earlier. With a PUT oscillator circuits can be build easily.

3.9 Amplifier

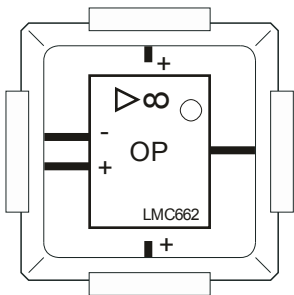

This brick contains an operational amplifier (op amp) with a very low input current of 2 trillionth amps (10^{-15}). This results in an input impedance of 1 Teraohm (10^{13}). Depending on the wiring, the operational amplifier can amplify the voltage differences up to 2.000.000 times. The amplifying factor is defined by the resistor ratio of in and output. The level of gain is in Bel (B) or decibel (dB) its 1/20 part - which is a logarithmic function. The voltage gain of 2,000,000 is equivalent to approx. 126dB.

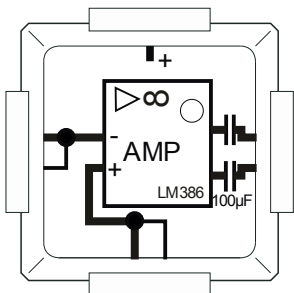

The LM386 is used to amplify weak audio signals. It has a maximum power of 0,25 watts at a output impedance of 8Ω. The features are similar to the operational amplifier and amplify the input level by a factor of 200.

3.10 Special modules

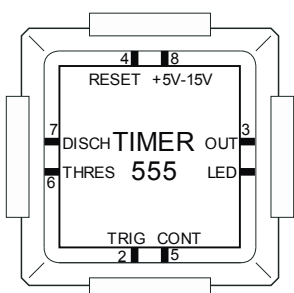

The timer 555 is used as a timer or for generating frequencies. Switch-on time, switch-off time as well as the shape of the output signals can be defined precisely. The brick can do different functions from oscillator to impulse generator.

4. Experimental setup - circuit

4.1 LED lights

Our first circuit consists of a voltage source and a LED-brick. The voltage source may be the battery-brick or an AC-brick. The LED is a modern form of lamp and is extremely energy efficient. The LED uses only a hundredth of the energy consumption of a comparable light bulb, because there is no wire to made glow. A recombination of electrons in the p-doped semiconductor, releases the produced light. Even LEDs heats up during operation, but they produce much less heat than light bulbs, when producing the same amount of light.

Note:

When building the circuit, please pay attention to the proper arrangement of the LED-brick. The LED lights up only when the LED is inserted the correct way. The cathode (negative pole) of the LED must be connected to the negative terminal of the voltage source as shown in the figure below.

The cathode (negative pole) of the LED must be connected to the negative terminal of the voltage source, shown in the figure below. The anode (positiv terminal) of the LED, however, has to be connected to the positive pole of the power source. Thus, the current flows trough the LED from plus to minus - in the so called technical current direction. The LED-brick has a series resistor on board. This is very important, because it prevents the destruction of the LED. If the LED would be connected to the power supply without a resistor, the LED would blow after a short lighting. The resistance limits the current flow.

Caution: The bricks have to be connected correctly. If the LED does not light up, please check the right connection of the bricks. It is always recommended to check polarization and connections before inserting the power-supply-brick.

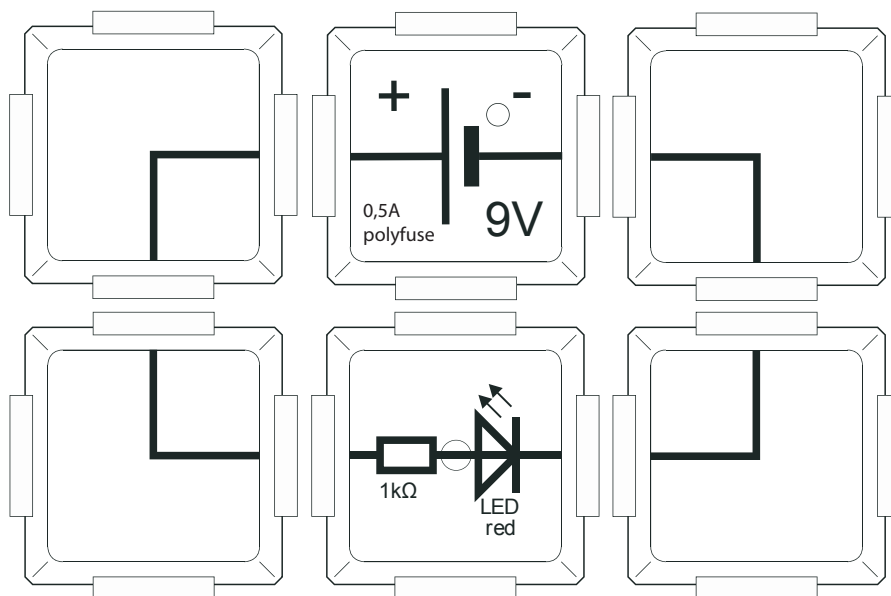

4.2 Open circuit

In this experiment, the LED-brick is inserted into the reverse direction and therefore does not light up. It's always important to keep the exact function of the LED in mind. The LED lights up only when it is inserted in the forward direction of the diode. The arrow indicates the current flow of the LED forward direction. The current must flow from the positive potential (plus) to the negative potential (minus) of the power-supply to allow a current flow and let the LED illuminate. The beginning of the arrow is called anode, the bar at the end of the arrow is called cathode. The bar at the cathode implies that the current can not flow when the positive potential of the voltage source is applied here.

The LED behaves like any other diode. It is comparable to a door, that can swing only in one direction. The cathode is marked on all components with a bar. In the forward direction it is connected to the negative pole of the voltage source. This bar indicates that the positive potential is blocked.

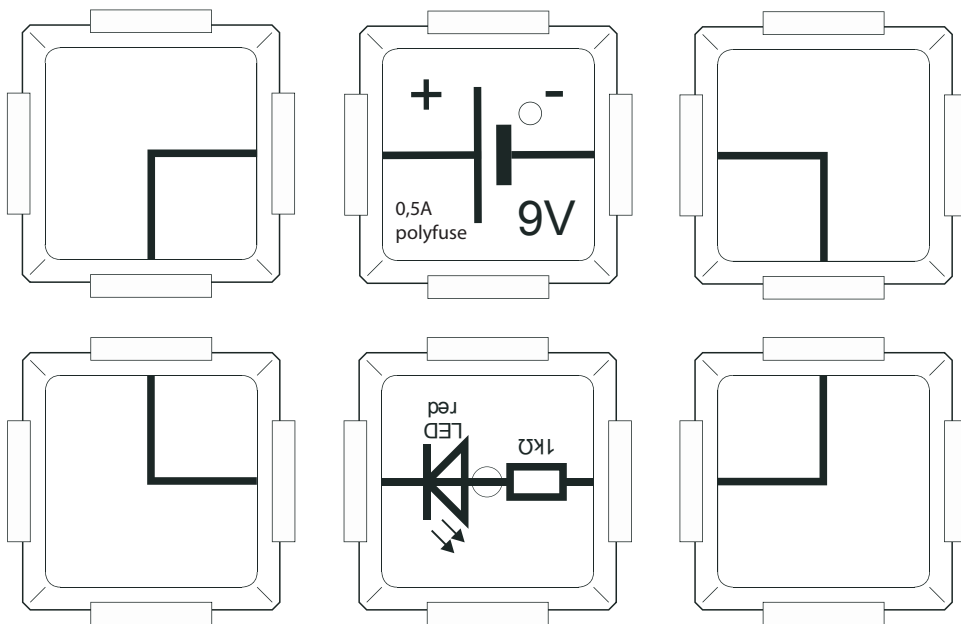

LED does not illuminate!

4.3 Two LEDs - parallel circuit

Our Brick'R'knowledge set has several LED-bricks, for example red, yellow, blue and green. All LED-bricks light up only when they are connected properly, i.e. with the anode at the positive potential of the voltage source. A parallel connection is always present when the current flow has two or more possibilities to find the way from the positive to the negative pole.

Because of the integrated resistor, both LEDs can be connected in parallel directly to a power supply. If an LED is connected directly to a voltage source without the resistor and the voltage is higher than the threshold voltage, it will be quickly destroyed, because there is no current limitation.

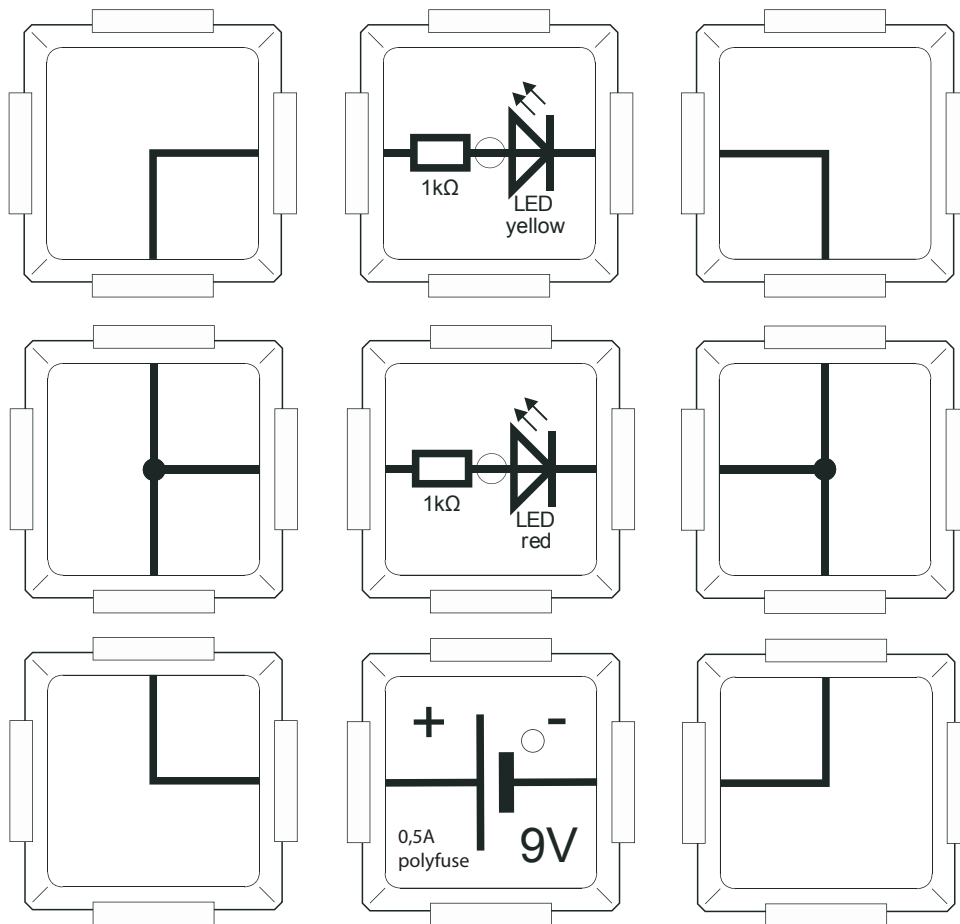

4.4 Battery polarity - measuring

Our next experiment, the characteristic of the LED can be used to detect the direction of the current flow. In this example the cathode of the red LED and the anode of the yellow LED are connected to the positive potential of the battery-brick. As a result, only the red LED will light up. By changing the polarity of the voltage source, the red LED won't light up, but the yellow one lights up. Now the negative terminal of the voltage source is connected to both LED-bricks. If a power-supply is connected, only one LED will light up, never both of them, this is called an antiparallel circuit. The circuit contains two $10\text{k}\Omega$ resistors in series with the LED-bricks to limit the current flow once again. This can also be used to check the polarity of the power supplies that have a higher voltage than 9V.

Attention: The maximum voltage of the power supply should be less than 24 volts. Please do not connect a brick directly to the main voltage of 230V. This may cause fatal injuries!

Attention: Never connect the two poles of a battery together, this will result in a short circuit with the danger of fire or explosion.

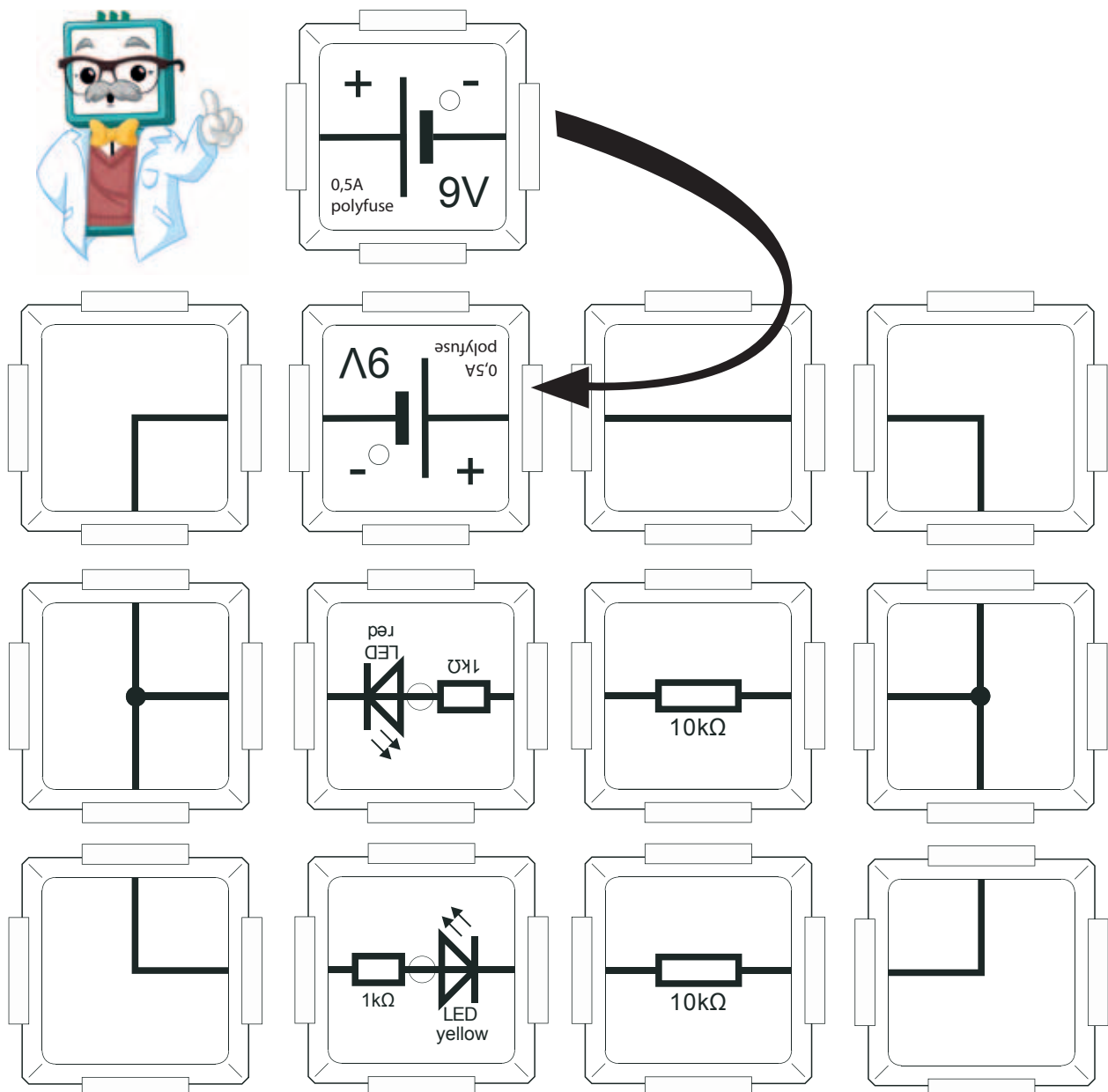

4.5 Ground and brick

One of the most important brick is the so called ground brick. The ground brick has one connector with four contacts. Usually the middle two contacts are used for signal or power connection. But the outer contacts are intended for the so call ground level. Which means technically a level of 0V. The ground brick connects the both inner contacts with the outer contacts. Therefore is possible to allow for a current return flow towards the 0V of a power supply invisible to the schematic symbols outside. The power supply of course must also be connected at one pole (usually the minus pole) to the ground using the ground brick. There is a power brick with an internal ground connection already done and visible in the symbol, and also a battery brick, where both poles are open, and can be connected with a ground brick to the ground level.

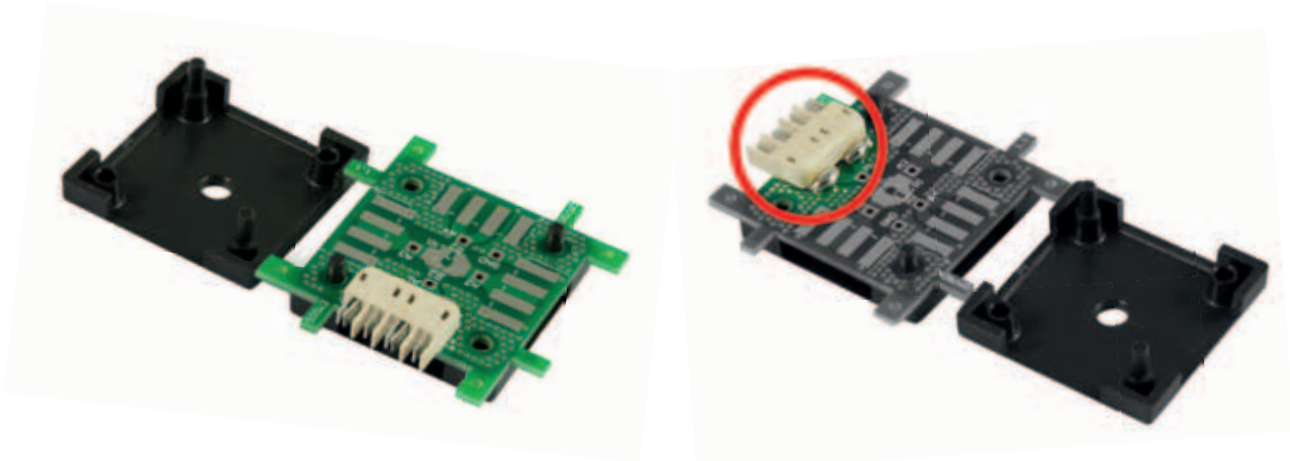

Please connect the bricks correctly, otherwise the connection will have an open or short circuit.

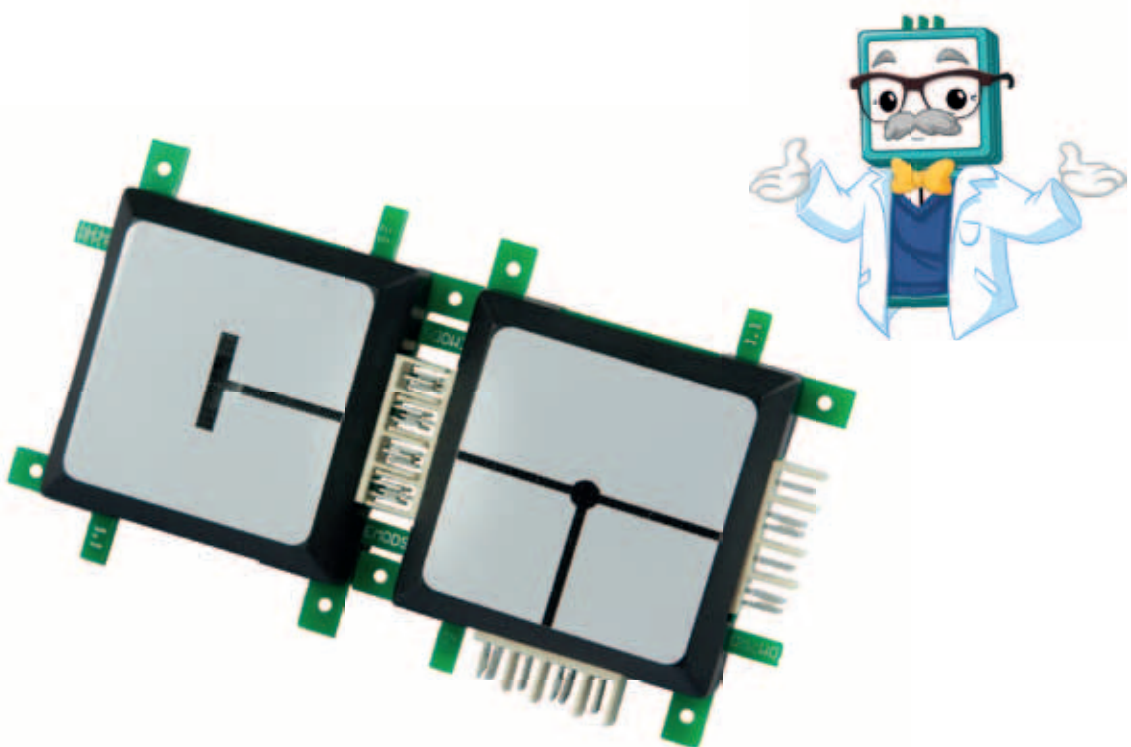

Here is an example of a correctly plugged connection. The connection consists of small contacts, that stuck mechanically and transmit the electrical energy.



The image below shows a incorrect connection. As you can see, the metal contacts are interrupted by the plastic pins. This allows no current flow.

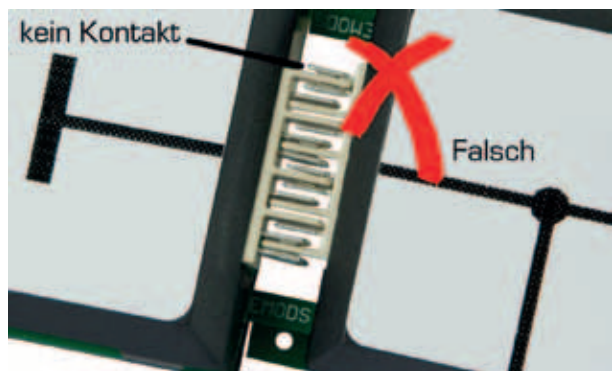

Caution: It is important to check the correct connection of the bricks. If they are not connected correctly this can lead to a short circuit or a malfunction of the circuit. If the connection is not working correctly, the current takes the lowest resistance way back to the power source, which might result in a short circuit, because the only resistance that has to be overcome, is the internal resistance of the voltage source.



Important: Always check the correct position of the contacts!

4.6 Simplified circuit with ground-brick

This is an example circuit with a ground-brick. This example reduces the number of bricks by 50 percent compared to a circuit with no ground-bricks.

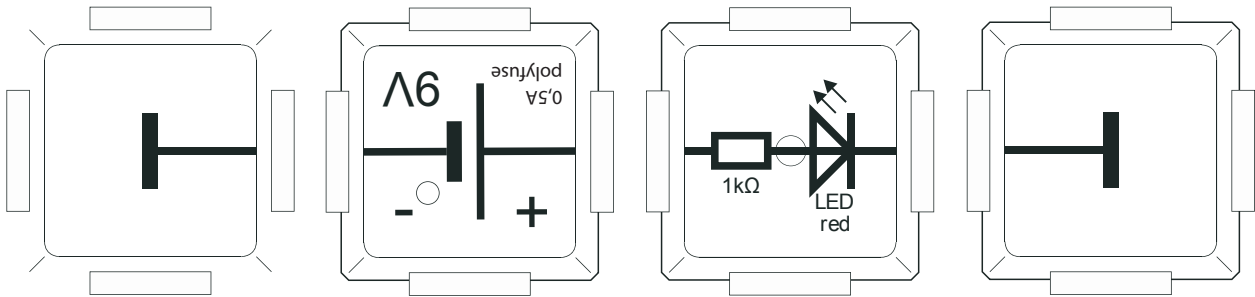

The experiment above is much clearer as in our first example and therefore more easy to understand. This ground symbol is also often used in professional schematics to enhance the overview of a circuit. The ground bricks here are used at both ends to close the current loop.

Note: The ground-brick saves time and leads to a better overview in complex and professional circuits.



Invisible ground flow

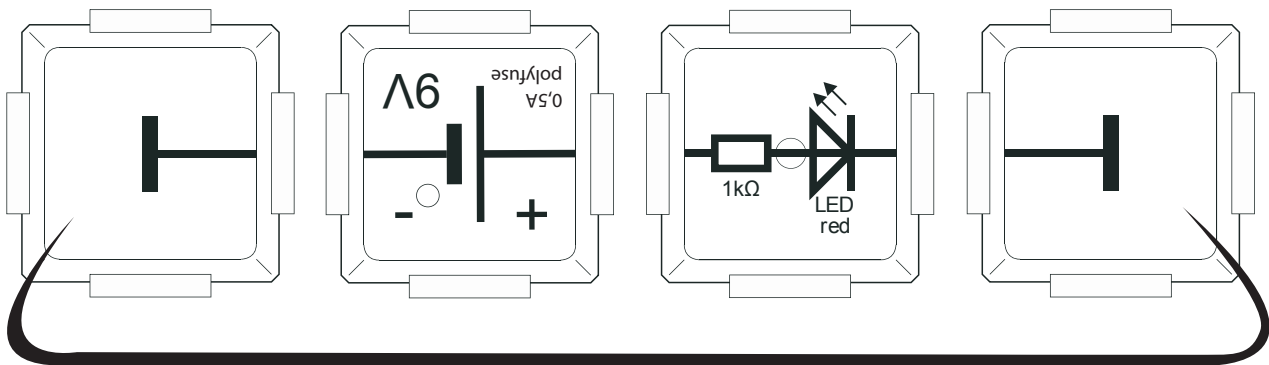

4.7 Circuit with push button

The next example shows the integration of a push button to control the LED.

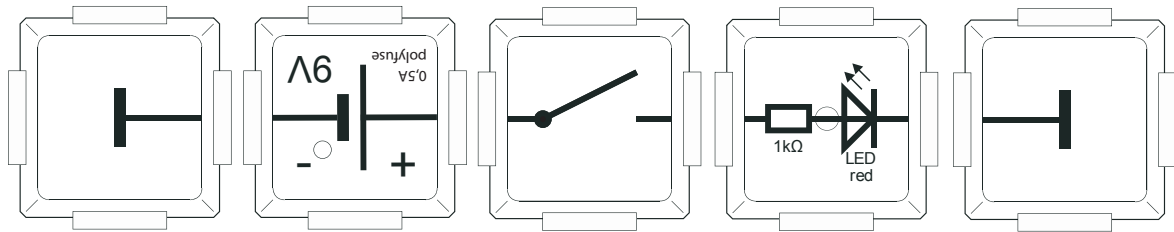

4.8 Circuit with switch

Another way:

In this example the switch works like a railway switch. The current can flow to the red OR yellow LED, but never to both at a time. The middle position stops the current flow, the upper position lights up the red LED, the downward position lights up the yellow LED.

Attention: Ensure the correct polarity of the LED-bricks.

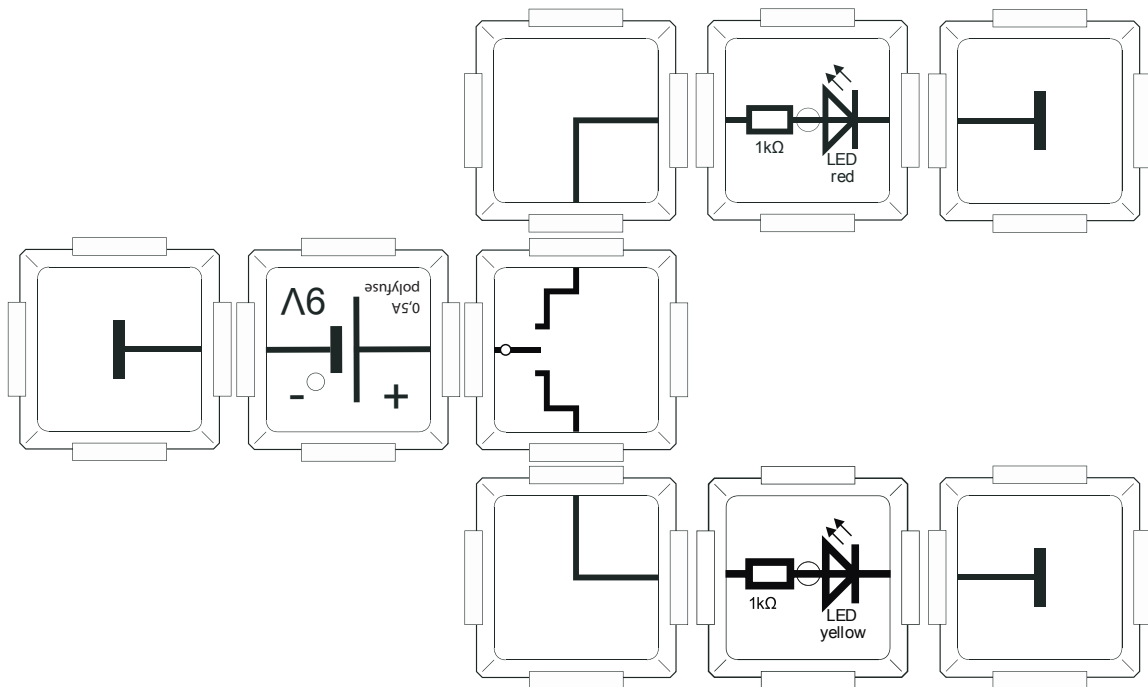

5. Digital logic with buttons

5.1 AND-circuit

Digital technology enables an intelligent interconnection of devices by implementing more complex functions. The term „digital“ means it has only two states for one signal. It is often used in contrast to analog, like digital or analog camera. An easy way to describe the difference is between a staircase and a line. The height change at a line (analog) takes place continuously, at the staircase the height change is done by steps (digital).

The following experiments show the simplest basic logical circuits (AND, OR, NOT and exclusive OR)

The AND circuit can be implemented with button-switches. Our example contains two button-switches to control the LED. This circuit is used for safeguarding hazardous machines. Only when two buttons (left and right) are held down at the same time with both hands, its guaranteed that no one gets hurt, and the machine will work.

Electronically the AND circuit is described by two series connected push buttons. Only when both switches are closed, the LED will light up. The circuit works only and only then when switch 1 AND switch 2 are activated.

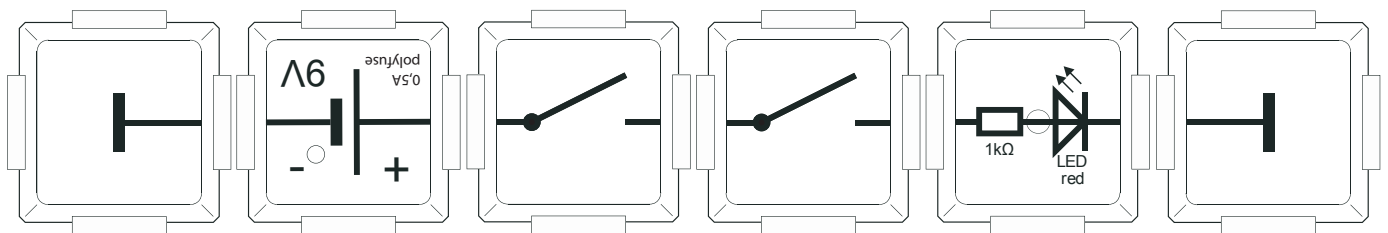

Digital technicians can represent the function of the AND operation in tabular form.

Switch 1	Switch 2	LED
Off (0)	Off (0)	Off (0)
On (1)	Off (0)	Off (0)
Off (0)	On (1)	Off (0)
On (1)	On (1)	On (1)

The red LED lights up only when the switch 1 AND switch 2 are pressed.

5.2 OR-circuit

The OR circuit implements an output signal when one OR the other or both are activated. For example you can spend 5 euros, when you have a 10 OR 20 euro note. In this case you can pay the bill even with both notes. That means there are three alternatives to light up the LED.

Even if both alternatives are selected, the event occurs. In electrical engineering this is implemented by a parallel circuit. This circuit requires the usage of two additional T- and junction-bricks, like shown in the example below.

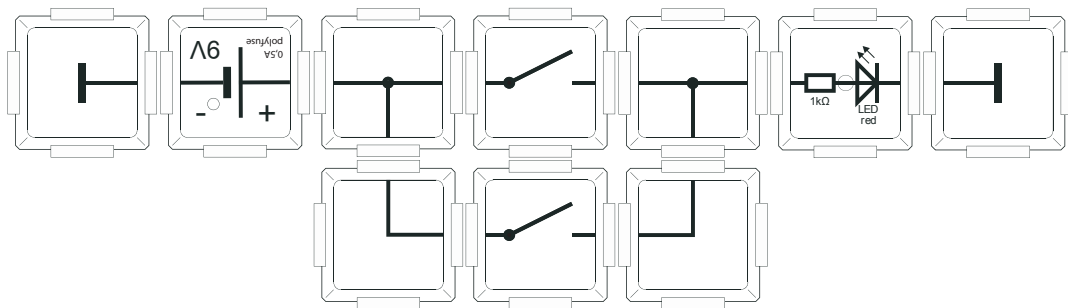

Tabular overview of the OR function:

Switch 1	Switch 2	LED
Off (0)	Off (0)	Off (0)
On (1)	Off (0)	On (1)
Off (0)	On (1)	On (1)
On (1)	On (1)	On (1)

The red LED lights up, when switch 1 OR 2 OR both are pressed.

5.3 NOT circuit

The NOT circuit is also referred as negation. For example, if the red LED traffic light is active, you can not go through the intersection. If the push button is pressed, the threshold voltage of the LED can not be reached, so that the LED turns off. If the button is not pressed, the current flows through the LED. The $1k\Omega$ resistor prevents a short circuit, when the button is closed.

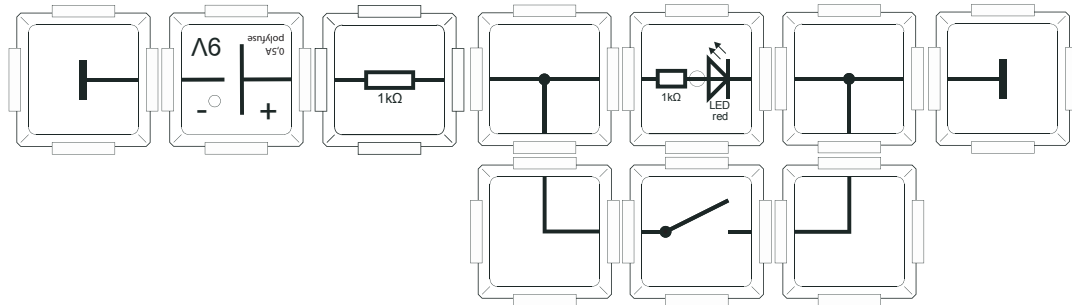

Tabular overview of the NOT function:

Switch 1	LED
On (1)	Off (0)
Off (0)	On (1)

The red LED lights up when the switch is NOT pressed.



5.4 Exclusive OR circuit

The exclusive OR operation can be found very often in electrical engineering. It is used as a two-way circuit in your home with the hall light or when encrypting data. In common parlance, the exclusive OR is called „either, or“. For example the hall light can be switched on by any of the two switches, no matter which switch is used for switching on or off.

This combination can be used in our circuit with switch- and the universal-brick. In electronics this circuit is called two way switch. One switch negates the signal from the other. The switch position is not important, the LED can be switched on from both sides. The LED does not switch on if the left switch is in position 1 and the right switch also in position 1 or when the left switch in position 2 and the right switch is also in position 2.

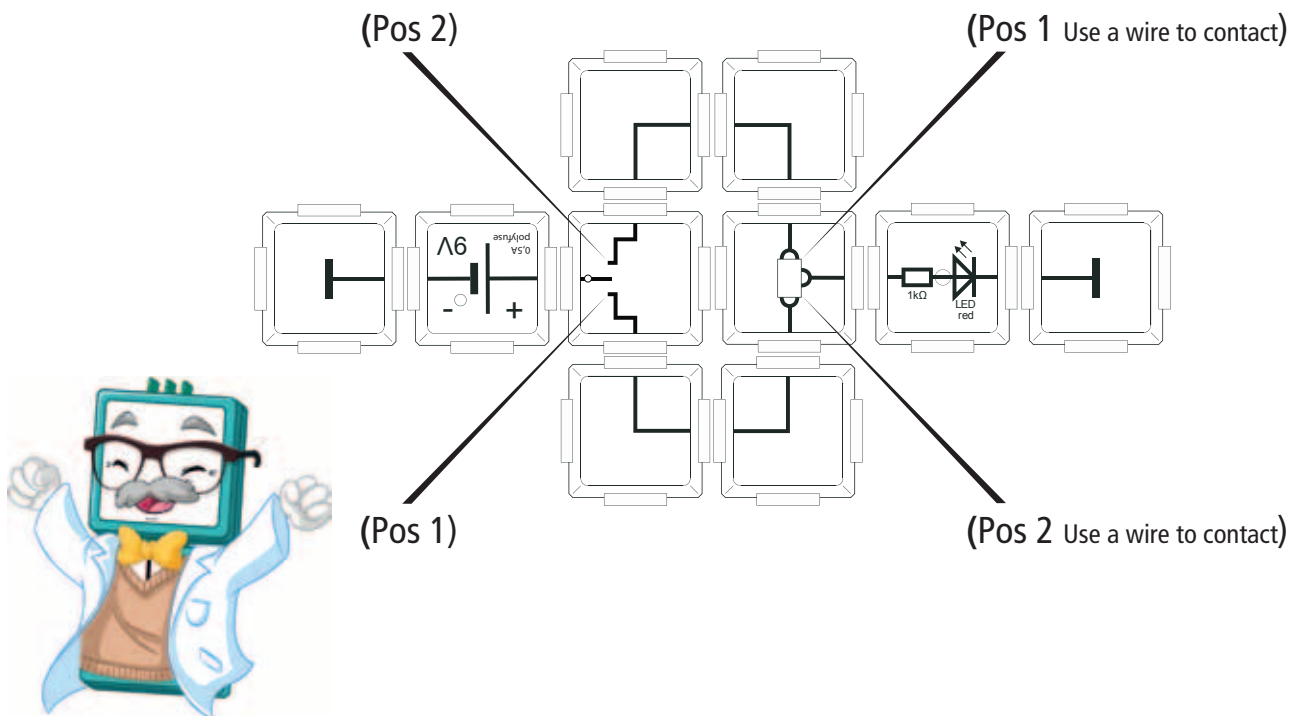

Tabular overview of the exclusive OR function:

Switch	Contacts	LED
Off (0) (Pos 2)	Off (0) (Pos 2)	Off (0)
On (1) (Pos 1)	Off (0) Pos 2)	On (1)
Off (0) (Pos 2)	On (1) (Pos 1)	On (1)
On (1) (Pos 1)	On (1) (Pos 1)	Off (0)

6. The resistor

6.1 Calculation of the resistance value

The electric resistance reduces the current flow. This property is essential for electronic circuits. The resistor manipulates the current flow or can be used for adjusting a desired voltage. Isolators and superconductors are extreme samples of an electrical resistance. The isolator has ideally an infinitely high, the superconductor no resistance. The electric resistance value is measured in ohm (Ω). If a circuit with a ideal voltage source has no resistance, the flowing current would be infinitely high. This is not possible in reality.

The electric current can be compared with a stream of water through a bottleneck. Should the same amount of water pass through the bottleneck, the pressure must be increased. Pressure is the equivalent of the electrical voltage, the water flow to the electric current and the frictional resistance of the water-pipe to electrical resistance. By increasing the water pressure, more water flows through the pipe in the same time.

The water pressure difference between input and output is analogous to the voltage drop by a electrical resistor. The properties of voltage U or V, current (I) and resistance (R) stand in a strict relation.

The following relation applies: Voltage is equal to the product of current and resistance: $R=U \times I$.

A current flow of 0.9A is reached when a resistance of 10Ω is applied at a voltage of 9V. In our circuit the resistor is much higher. That will at the same voltage level reduce the current flow.

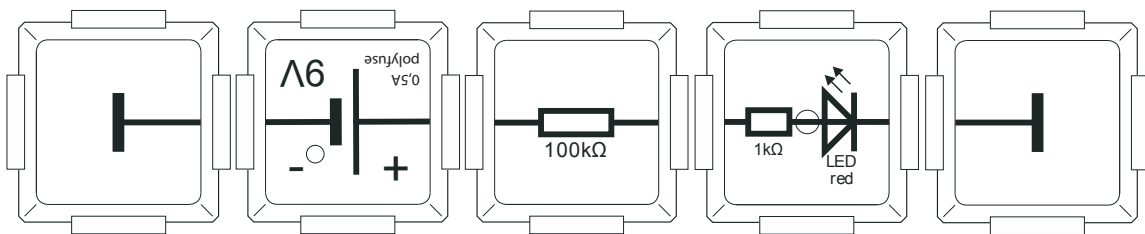

If the resistor-brick will be replaced from 100k to 10k and 1k. The current calculates as follows:

$$I(100k\Omega) = \frac{9V}{100k\Omega + 1k\Omega} = 89.1\mu A$$

$$I(10k\Omega) = \frac{9V}{10k\Omega + 1k\Omega} = 818\mu A$$

$$I(1k\Omega) = \frac{9V}{1k\Omega + 1k\Omega} = 4.5mA$$

6.2 LDR - Light dependent resistor

Our LDR-brick changes its resistance value depending on the intensity of the light entering the LDR.

If the LDR-brick is illuminated by light, it changes its resistance value in favor of the conductivity. The value of the resistor is reduced and the current flow is increasing. Its resistance value reaches a very high amount of several 100k Ω in the dark, but a very low level of a few 100 Ω in brightness. The change is approx. a thousand times. In the following experiment the red LED lights up only when the LDR is illuminated and diminishes at darkness. The effect has a short delay time.

The series circuit experiment contains a power supply, LDR- and LED-brick.

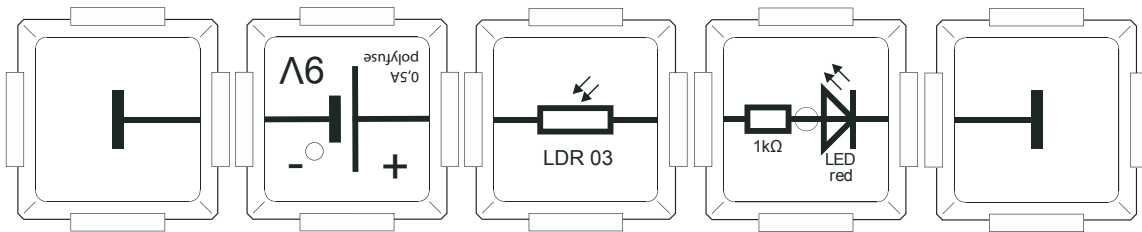

6.3 The parallel circuit

We call this circuit a parallel circuit, because the current flow is splitted into two path. The results of this effect can be observed with the changing light intensity of the LED-brick. Since both resistors have the same value of 100kΩ, the current has two equal ways to reach the LED, when the button is pressed. The total resistance of the parallel resistors is halved to 50kΩ. If the button is pressed, the light intensity of the LED increases.

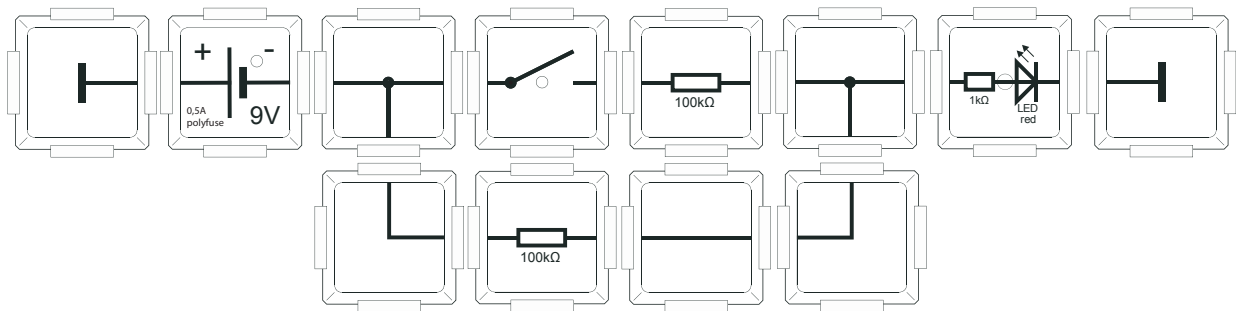

Expressed arithmetically, all resistor values are added reciprocally:

$$\frac{1}{R(\text{ges})} = \frac{1}{R(i)} + \frac{1}{R(i+1)} + \dots + \frac{1}{R(n)}$$

transformed to:

$$R(\text{ges}) = \frac{R(i) * R(i+1) * \dots * R(n)}{R(i) + R(i+1) + \dots + R(n)}$$



The total resistance of the parallel circuit is given by the quotient of the individual product resistance total

In this example the calculation with concrete values:

$$R(\text{ges}) = \frac{100,000\Omega * 100,000\Omega}{100,000\Omega + 100,000\Omega} = 50.000\Omega$$

The total resistance of the circuit is 50,000Ω. Without pressing the button, one path of the parallel circuit is not connected. That doubles the total resistance to 100kΩ

6.4 Series circuit

To understand the total resistance and their impact to a series connection, we use the following sample.

The following applies:

$$R_{(ges)} = \sum_{i=1}^n R(i) = R_1 + R_2 + \dots + R_n$$

The push button is in parallel to one of the resistors. By pressing its value will be shorted. Therefore the button can switch the total resistance between either 200kOhm when not pressed or 100 kOhm when pressed down. This will also change the intensity of the LED.

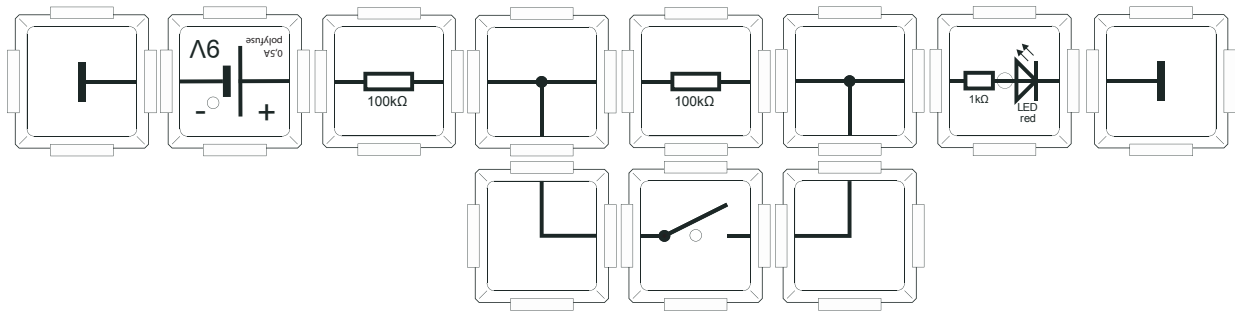

The calculation of the resistance is very simple and follows this calculation:

$$R_{(ges)} = 100,000\Omega + 100,000\Omega = 200,000\Omega, \text{ for the unpressed button}$$

$$R_{(ges)} = 100,000\Omega, \text{ for the pressed button.}$$



6.5 The potentiometer

The following experimental set up contains a potentiometer-brick. The potentiometer acts like a voltage divider, so its important that the three connectors are connected, like in the following example. Its important that the wiper is not connected directly to the ground or the positive pole of the power supply. Otherwise the potentiometer brick can be destroyed by a short circuit.

Only the LED-brick should be connected to the wiper-contact. By moving the wiper to the right, the LED lights up to the maximum of 9V, by turning to the left, the voltage decreases, until 0V are reached. The exact middle position of the potentiometer sets a voltage of 4.5V. The output voltage at the wiper can be defined between 0V and 9V in a continious matter.

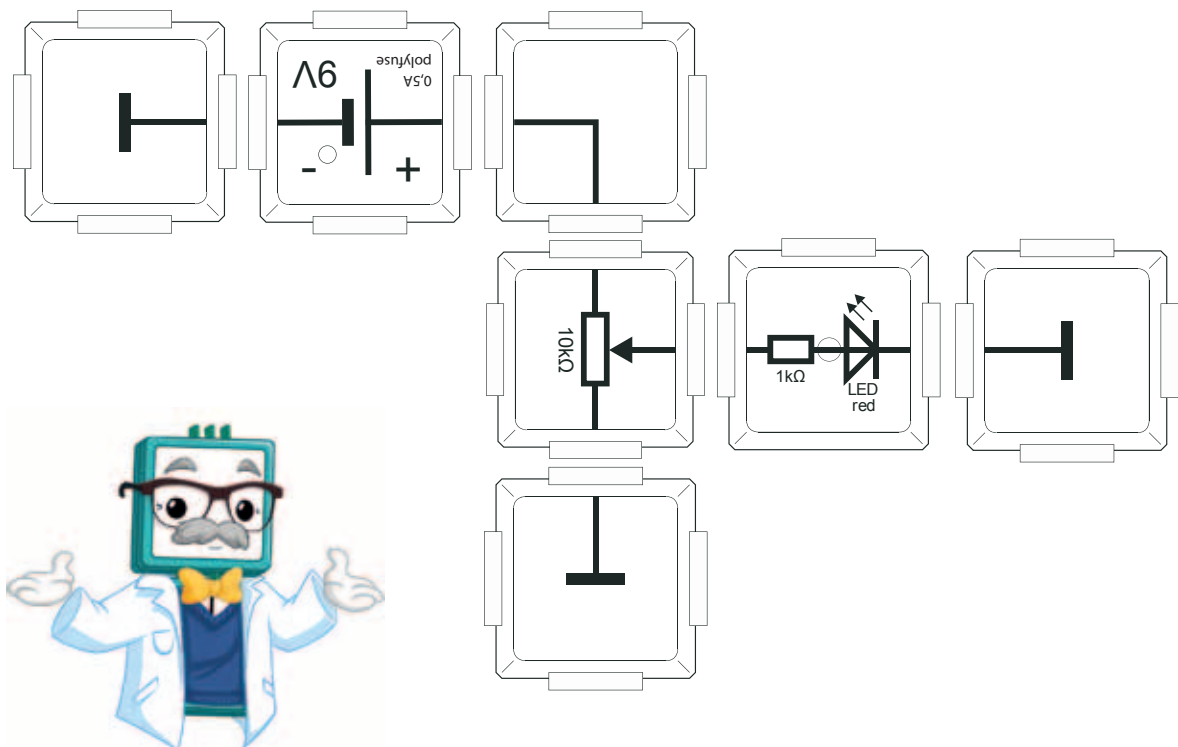

6.6 The threshold voltage

The term threshold is used in electronics for semiconductor elements. Our advanced set contains semiconductor elements, like transistor- or LED-bricks.

The threshold describes the value, that must be exceeded to operate a semiconductor. In the following experiment we build a circuit that lights the LED up, when the threshold is exceeded. We determine this by the position of the potentiometer wiper.

In our example the wiper is positioned at the left and then slowly turned to the right. You can see that the red LED will light up first, the other colors will follow. Like the other experiments before, the potentiometer acts again like a voltage divider. To avoid damage to the components, be careful to connect the wiper contact position exactly as in the schematic below to the LED-bricks. Otherwise there is danger of a short circuit. At the left position of the wiper there is a voltage of 0V, while at the right position the maximum of 9V is reached and the LED lights up bright.

For low power LEDs (2mA) we list the rough threshold voltage below, which also depends on the color of the LED. The red LED will light up at first, while the blue one will be the last.

- red 1.5 - 2.2V,
- yellow 1.7 - 2.5V,
- green 1.7 - 2.5V,
- blue 2.7 - 4V

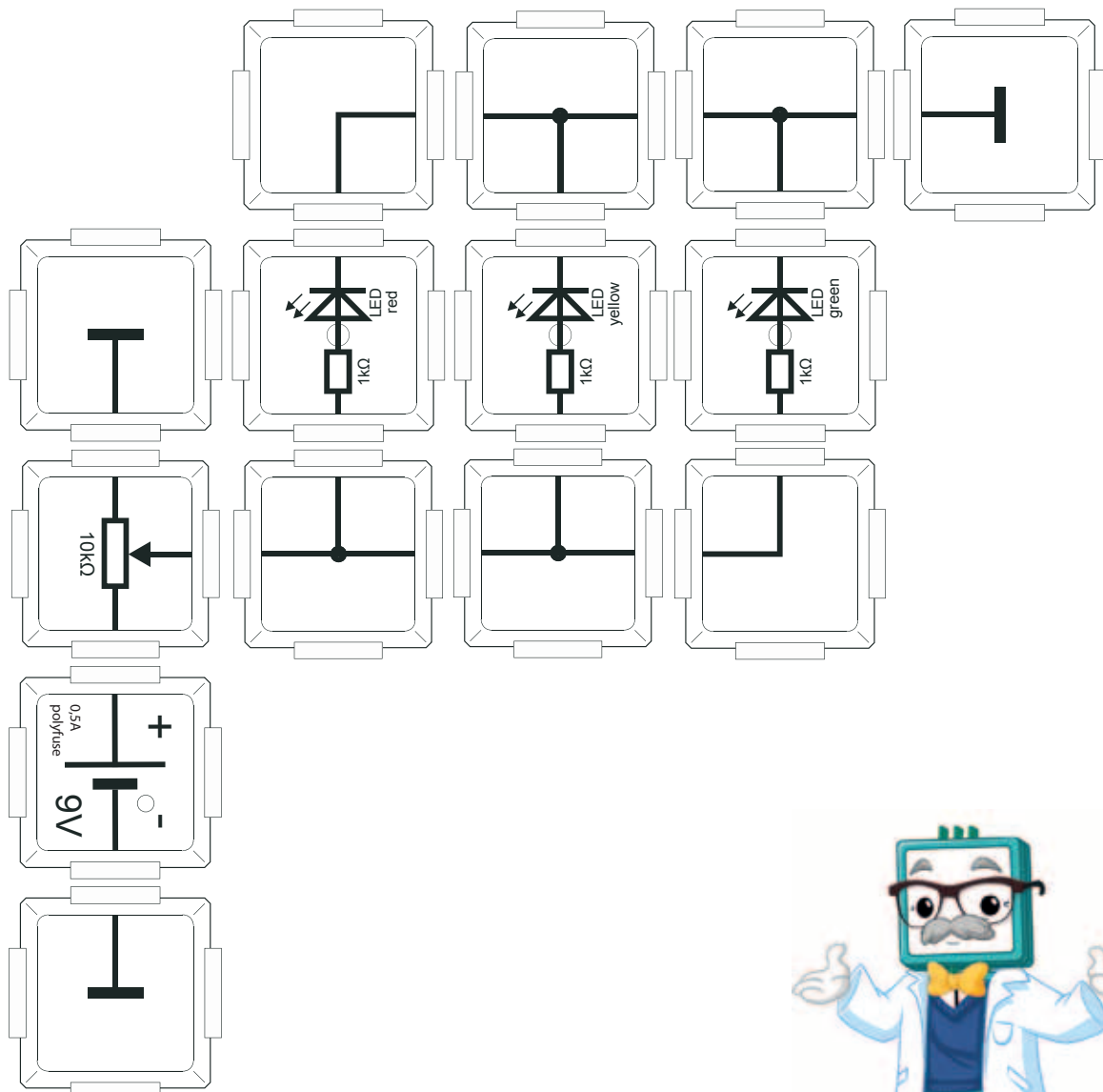

7. Capacitor

7.1 Charging and discharging with a 1µF capacitor

In the following circuit a capacitor with a capacitance of 1µF is charged and discharged. Charging is done in switch position 2, while discharging is done at position 1.

The energy brought to the capacitor is:

$$E = \frac{1}{2} * C * U^2 = \frac{1}{2} * 1\mu A * (9V)^2 = 40.5\mu\text{Joule}$$
 which is very low. The discharging time is calculated by an exponential

function or approximated by the following function:

$$t = 5 * C * R = 5 * 1\mu F * 1k\Omega = 5ms$$

Therefore the LED lights up only for a short time when the capacitor is discharged. The charging and discharging time for the whole process in theory is infinite. That's why the charge and discharge time of capacitors is defined for 99 percent of the reached maximum charge or when 99% discharged.

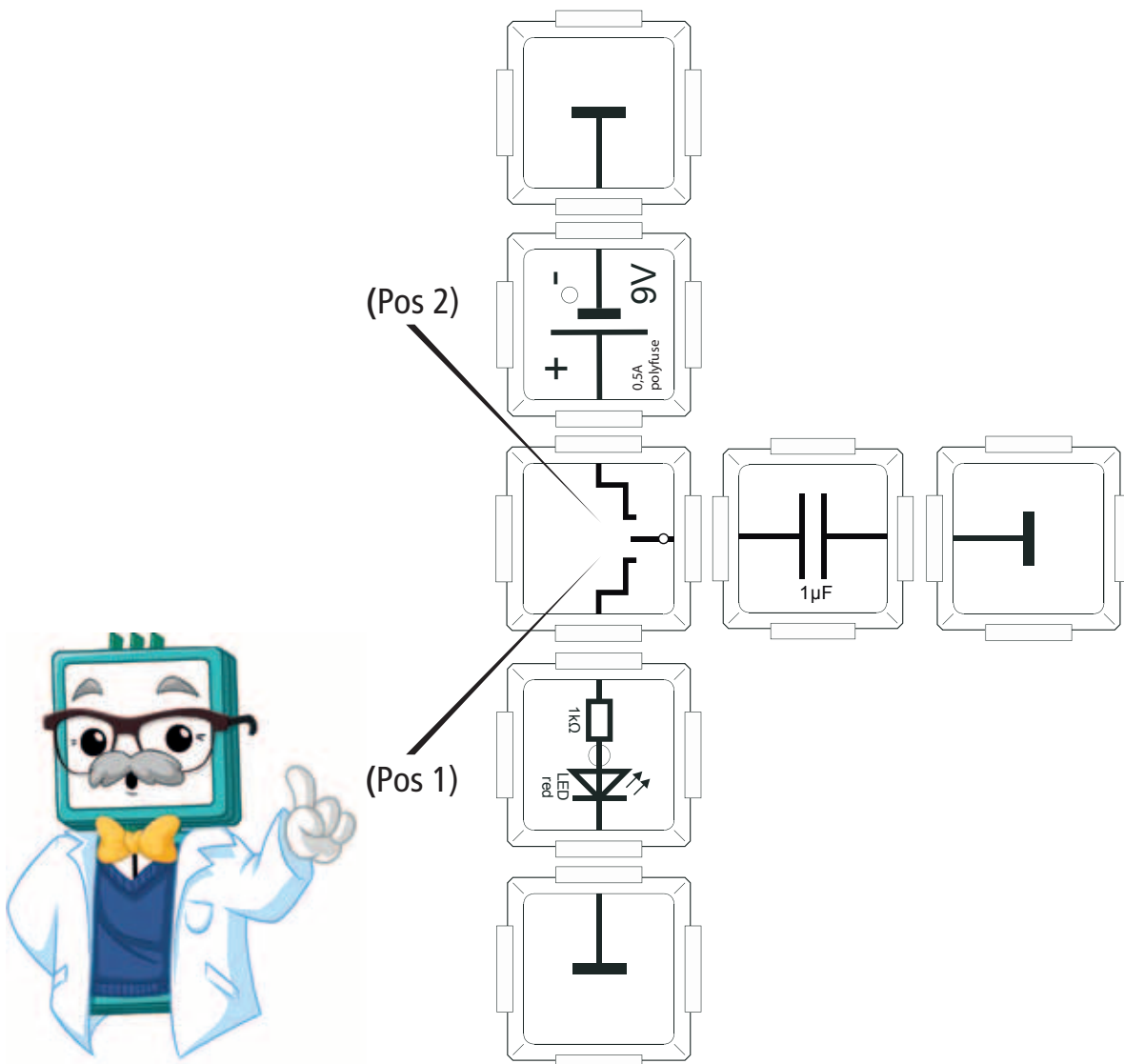

7.2 Capacitor with 10 μ F

This example is similar to example 7.1. The circuit shows charging and discharging of the capacitor. The charging is done at position 1, while the capacitor discharges at position 2. The energy brought to the capacitor is:

$$E = \frac{1}{2} * C * U^2 = \frac{1}{2} * 10\mu A * (9V)^2 = 405\mu\text{Joule} \text{ that's still very low, but 1,000 times higher than in the example before.}$$

The charging and discharging time is described:

$$t = 5 * C * R = 5 * 10\mu F * 1k\Omega = 50ms$$

The capacitor has 10 times more capacity and the LED lights up longer.

This process can be repeated indefinitely.

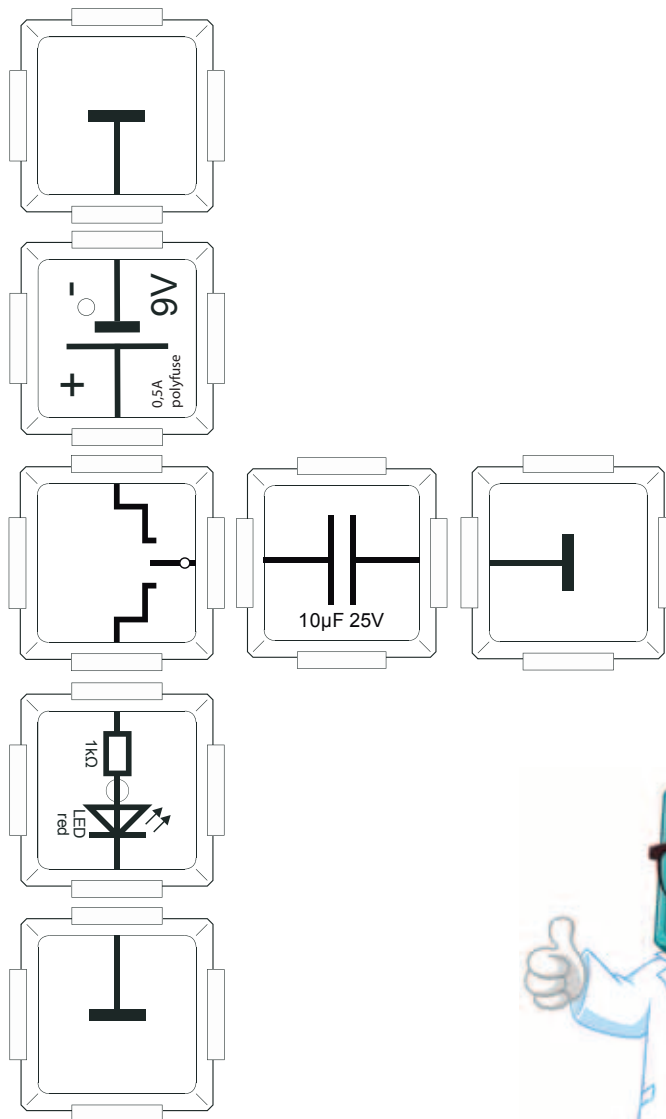

7.3 Recharge capacitor

It is much easier to use only one push button instead of two or more push buttons. The following circuit with an included capacitor is discharged only when the button is pressed. The antiparallel LED-bricks are inserted into the circuit that are in series with the capacitor and resistor. That's why we can see the charging and discharging of the LED with a short flashing of the red and yellow LED. If the circuit is connected to the power supply, the yellow LED lights up as long as the capacitor is loaded. By pressing the push button, the red light will flash for a short moment, while the capacitor is discharged. If the button is pressed in quick succession, the LEDs will flash alternately. The $1\text{k}\Omega$ resistor is very important because it prevents a short circuit of the battery-brick.

The current flow direction changes when changing between charging and discharging.

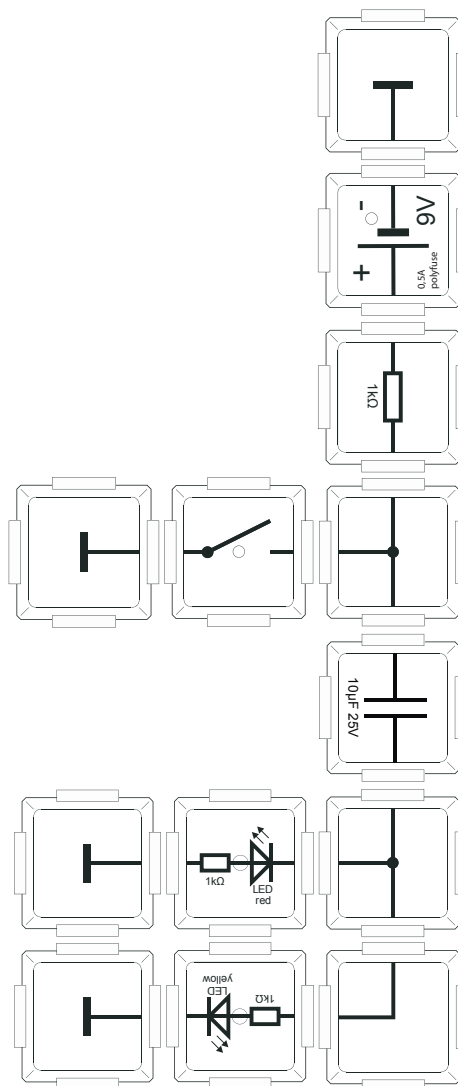

8. Inductance

8.1 Charging and discharging a coil

A coil has similar properties to a capacitor. It can also store energy, but uses a magnetic field instead of an electric field to store the energy. Therefore the charging and discharging process can be described similar to the capacitor. It shows that in contrast to the capacitor the coil uses the current flow as major factor. Both components behave complementary to each other.

$$E = \frac{1}{2} * L * I^2 = \frac{1}{2} * 10mH * \left(\frac{9V}{200\Omega}\right)^2 = 10.125\mu\text{Joule} \text{ which is still very low}$$

The discharging is described by an exponential function, but can also be approximated by:

$$t = 5 * \frac{L}{R} = 5 * \frac{10mH}{1100\Omega} = 45.5\mu s$$

When pressing the push button, the LED remains dark, because it is reverse biased. When the button is released, the coil tries to maintain the current flow. As a result the LED lights up for a short moment, because the current flows in opposite direction.

This process can be repeated indefinitely.

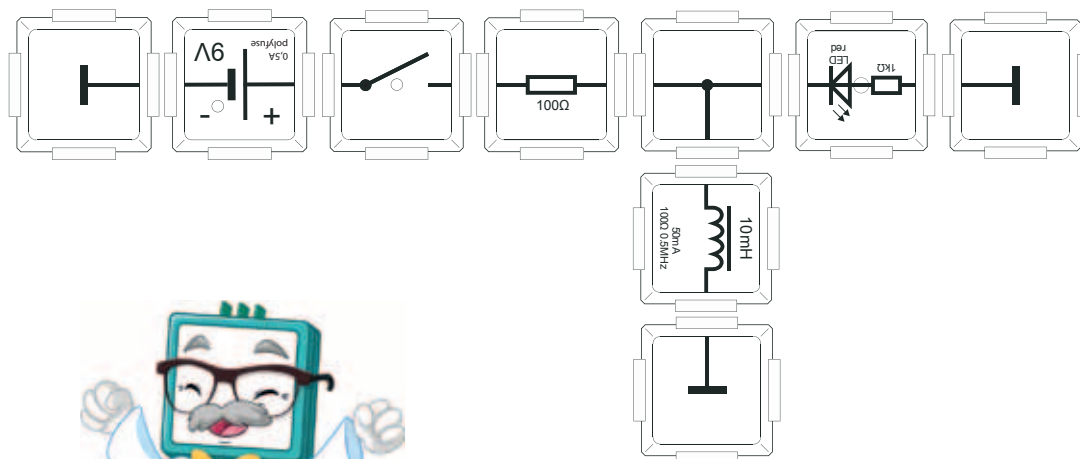

8.2 Induction

In order to explain the charging and discharging process, the red LED signals the charging, while the yellow LED lights up when the coil is discharged. By pressing the button, the coil builds up an magnetic field, that changes direction when the button is released and current still flows in the same direction through the coil, but now through the yellow LED.

When charging the coil, the current is set to 45mA from a 0mA basis, this will create a positive magnetic field. When the circuit is opened again, the current changes from 45mA to 0mA, and the magnetic field changes direction but the current still flows in the same direction. The red arrow indicates the direction of the current in the closed circuit, the yellow arrow shows the open circuit, while the yellow LED lights up for a short moment.

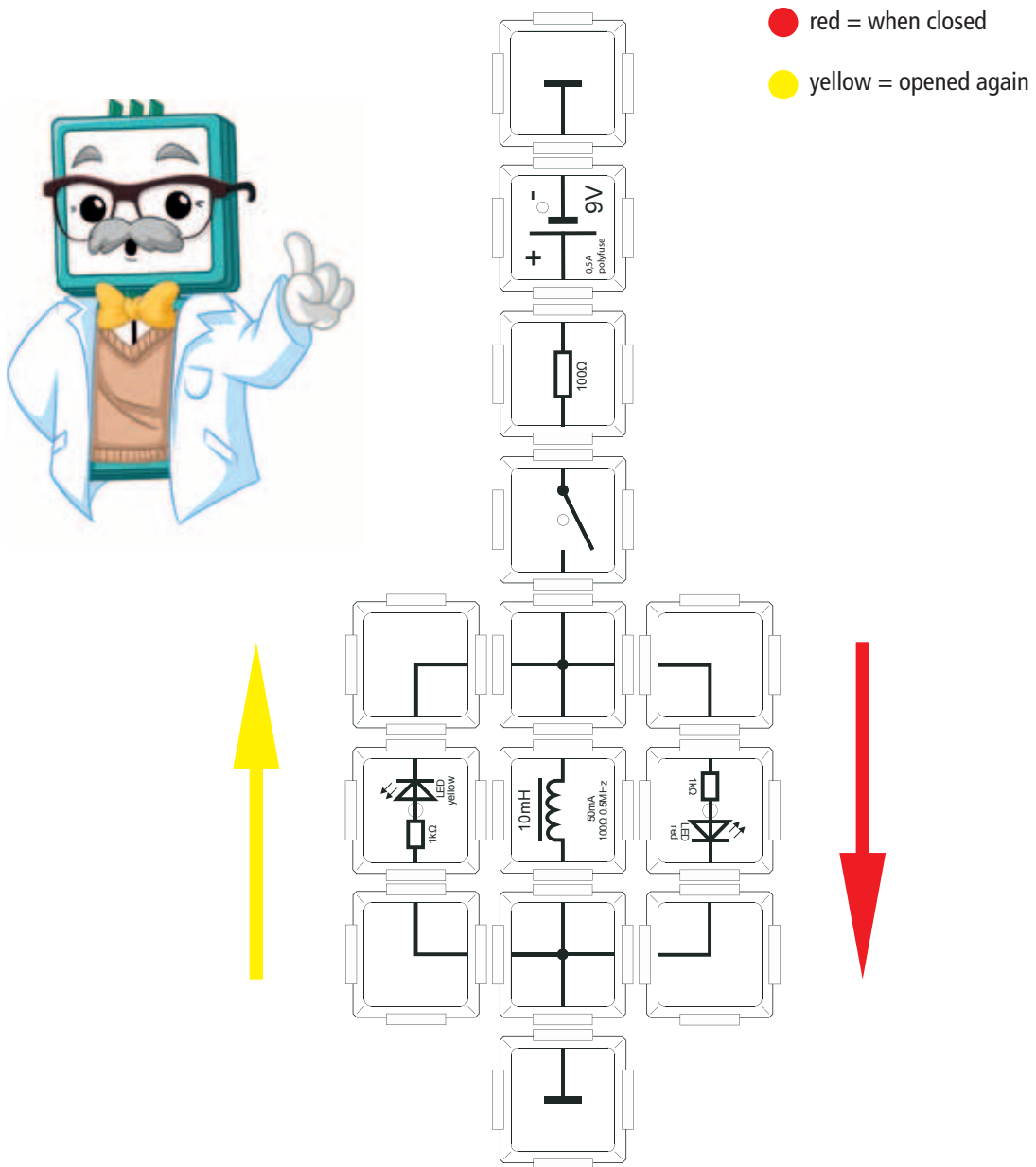

8.3 Inductive voltage

The coil can produce very high voltages, that are called inductive voltage. This occurs when the current flow gets a change in the value through the coil. The faster the change is made, the higher is the induced voltage. A voltage of several 100V can occur, when using a switch, because then the change is done in a very short time. Again, there is a similarity to the capacitor, when a short circuit occurs, a high current can be measured.

Although the amount of energy in here used coil is usually not health-hazardous, an electric shock should be avoided at any time. In this experiment a neon lamp with a high operation voltage of 70 volts will light up when the switch is opened again. To see this effect, it's necessary to dim the room, because the effect is very small.

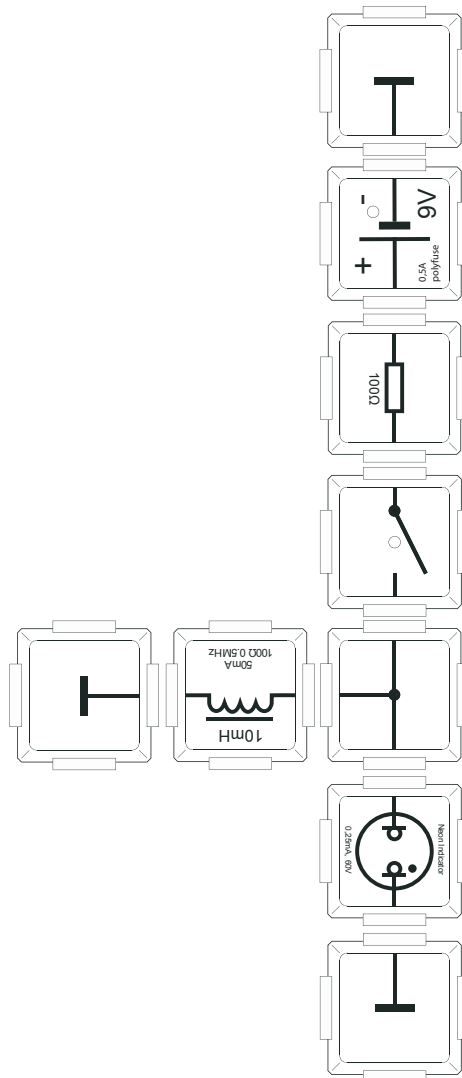

8.4 Energy Harvest

Energy harvesting is used to collect energy in smallest amounts. In the following experiment the electrical energy is transferred from the coil to a capacitor. In the first step, the coil is charged by closing the push button 1. After opening the switch, the current flows through the red LED, which lights up for a moment till the energy is transported to the capacitor, which is charged a little bit. Then when switch 2 is pressed, the capacitor is discharged and the yellow LED flashes for a short moment if enough energy has been collected.

The transport of the energy from the coil to the capacitor can be seen by a short flash of the red LED, the further transport from the capacitor to the ground is visualized by the yellow LED.

Note: Switch 1 has to be pressed several times to charge the capacitor that much, that the yellow LED lights up brighter and becomes visible, without pressing switch 2 in between. Each time a small amount of charge is transported to the capacitor.

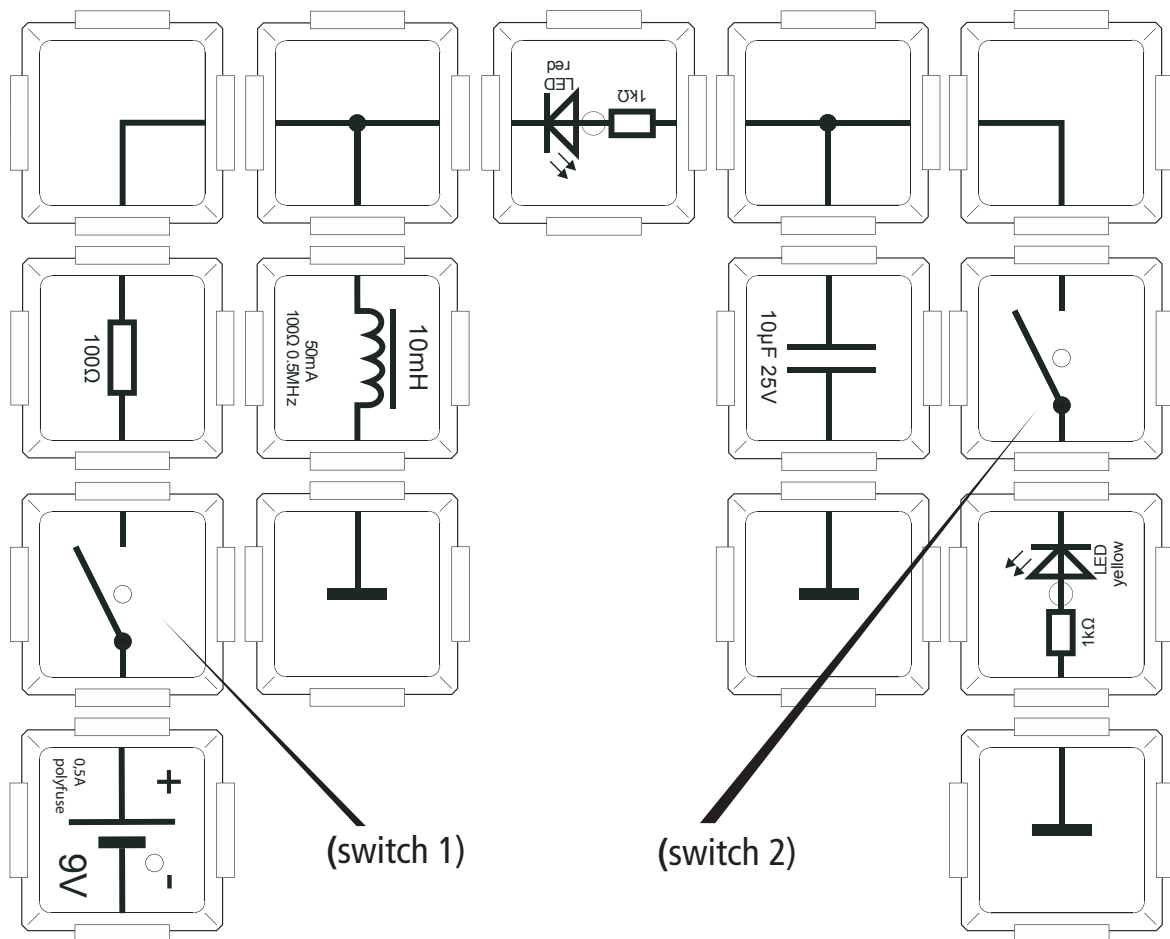

9. Transistors

9.1 Transistors as switch

This set-up shows the classic operation of the transistor as a switch. The transistor is a semiconductor device that allows a current flow between collector (C) and emitter (E) when a current flows into the base (B). The base current is about one hundredth less than the collector current. Transistors have a current amplifying characteristic. The gain is determined by comparing the base current to the collector current.

Transistors are often used for increasing the amplitude of a oscillator signal, because they respond very quickly when used as an electronic switch. The circuit shown is called emitter-circuit, because the emitter is connected to the 0V/ground. If the switch is next to the base, the red LED lights up. The base current allows a current flow between collector and emitter, as it enters charge carriers between the two n-layers in the transistor. This experiment uses an npn-transistor, therefore the base forms the p-doped layer.

Note: Semiconductors are sensitive components. The transistor is destroyed when the base (B) is directly connected to the battery, without the protective resistor.

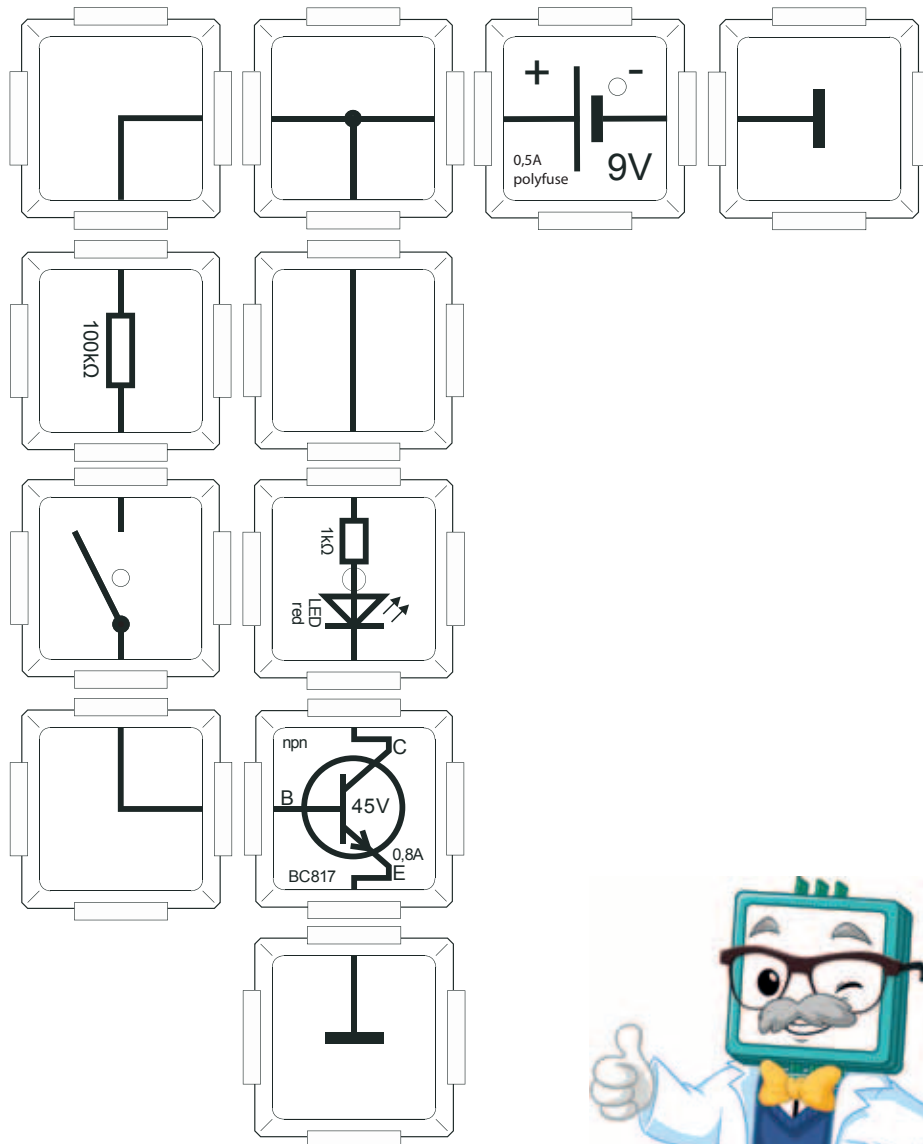

9.2 Transistors in darlington configuration used as touch sensor

The Darlington circuit contains two connected transistors. Operation can be described by a cascade, wherein the first transistor serves as a preamplifier of the second transistor. The achieved gain is approximately the product of the two individual gains of the transistors used. To let the red LED light up, only a few microampere into base are needed. The achieved current amplification is that high, that applying a fingertip at the seperately crossed-brick is enough to get a current flow through 100 kOhm resistor into the base to let the LED light up.

You do not need to worry about your health, because the current is not noticeable.

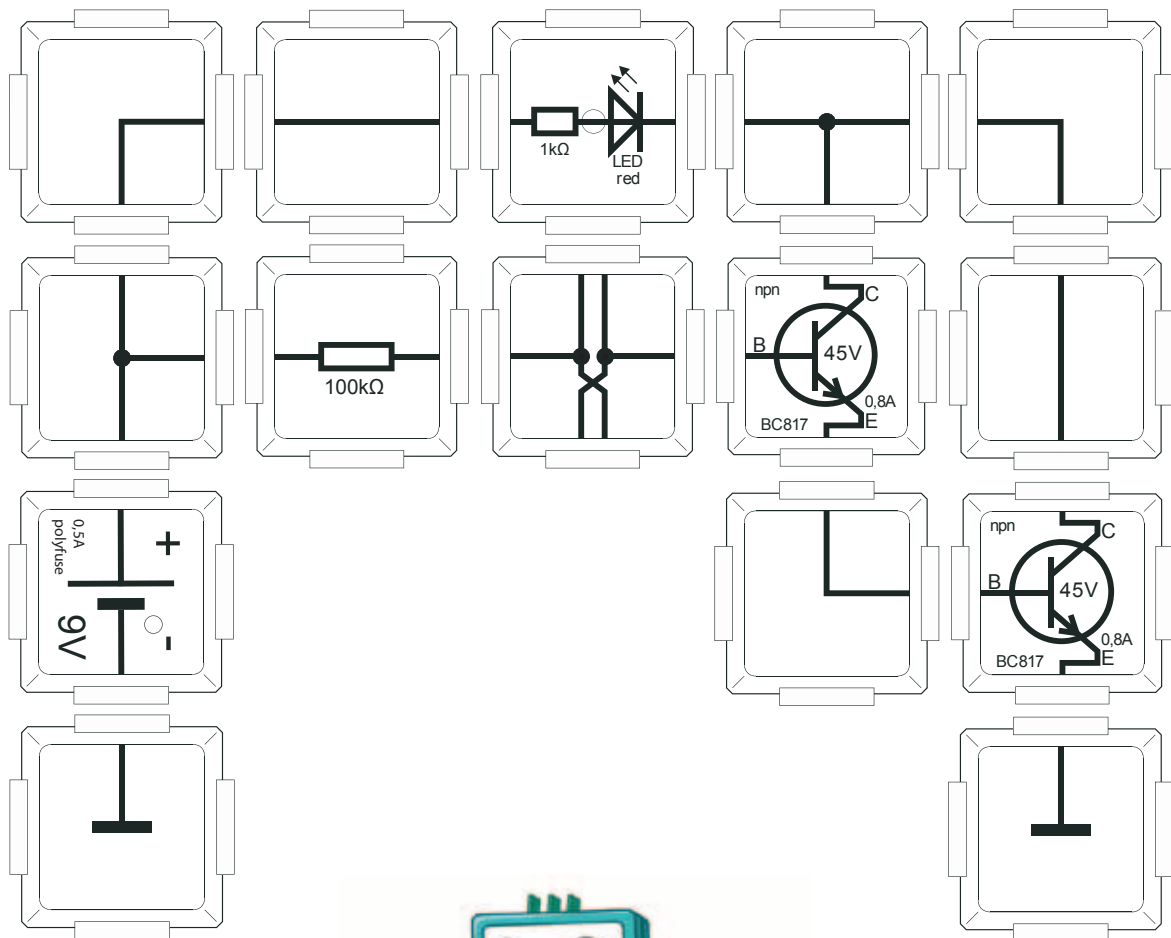

9.3 Darlington circuit with capacitive touch sensor

The darlington circuit of example 9.2 is now increased by an additional transistor, so that the gain achieved is now in total about 1,000,000 times. That is so high, that the AC current through the capacitor is sufficient to let the red LED light up. We have already used the capacitor in DC circuits. When the capacitor has completed charging, no current flows because of its infinite resistance. What happens, when AC voltage is applied? The rapid changes of charging and discharging allows a current flow.

This looks like a normal resistor, and the value of this resistiv part of a capacitor is depending on its capacity and the frequency of the AC voltage source. The higher the frequency and capacity value, the lower the resistance. The overall gain of all three transistors is large enough to amplify the current of a few nano-amps, so that the red LED lights up, when the open side of the capacitor-brick is touched by a finger, and AC sources are around (powerlines for example). The darlington circuit can also be triggered by spontaneous electrostatics, then the LED light up only briefly.

Again there is no health hazard, because the voltages are very low.

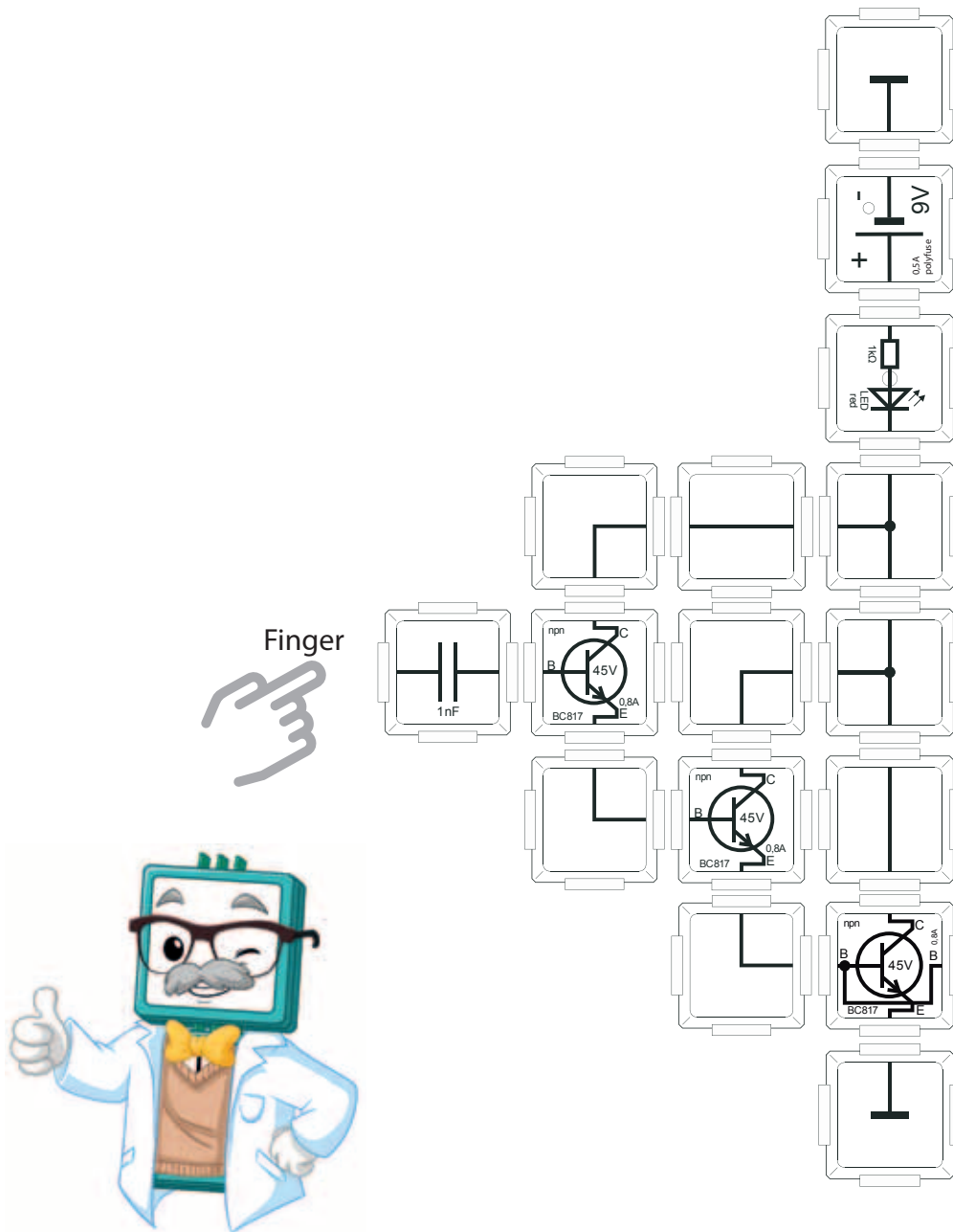

9.4 LDR and transistor

Our LDR-brick changes its resistance not mechanical, like the potentiometer, but depending on the light entering the sensor. If the LDR-brick is getting light, the resistance value becomes smaller and the current flow is larger. Its resistance value reaches a very high amount of several 100k Ω at darkness, but a very low value of a few 100 Ω with a bright light, the maximum change is about 1000 times. The potentiometer is connected in series with the LDR-brick, that allows to find the threshold of the red LED by turning the knob. At the left position the LED does not light up, at the right position the transistor is active and the LED lights up. The optimum for the threshold and a maximum sensitivity can be found between both values.

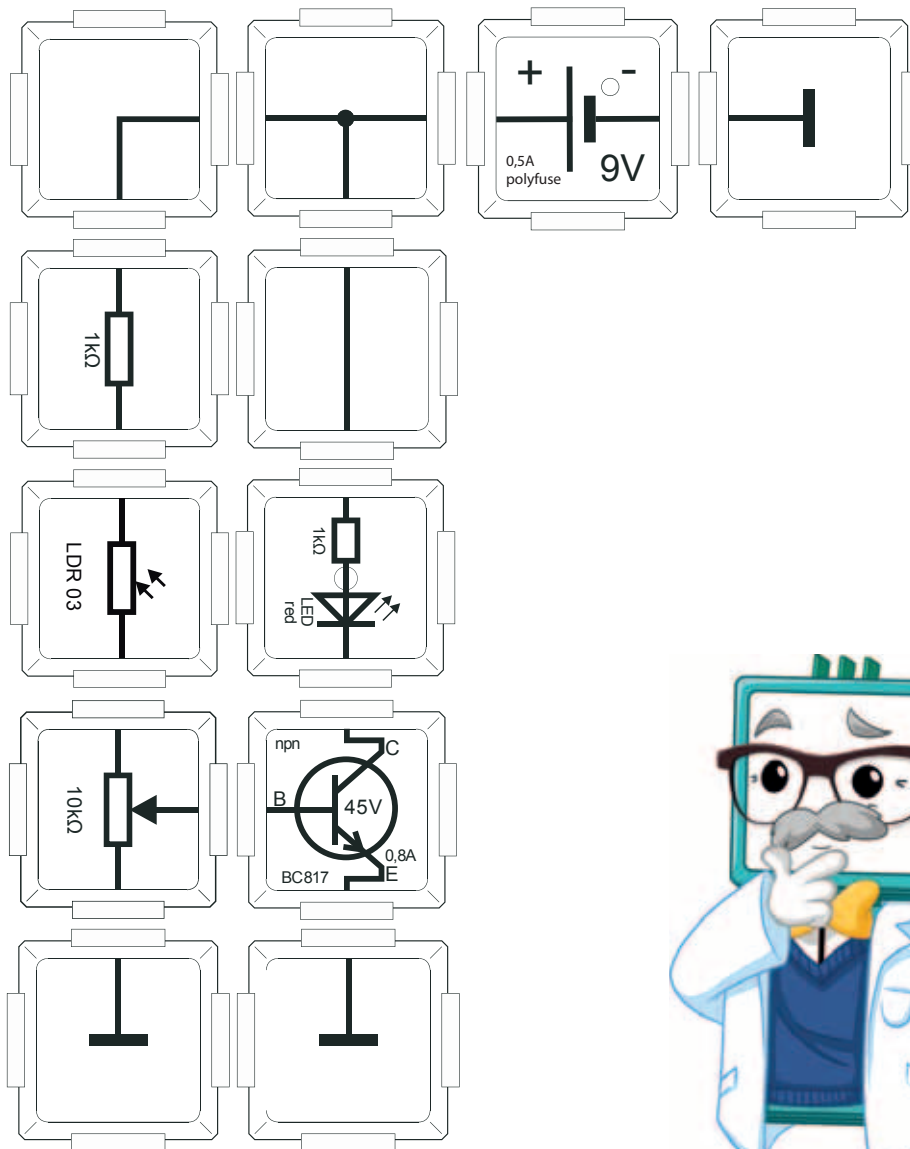

9.5 LDR used for night light with transistor and resistor

As in example 9.4, it's not very useful to automatically switch on additional lamps during daylight. Rather it's necessary to turn on the light when it's getting dark. That's why we connected this time the LDR with one end to the ground brick. This will result in a different functionality, exactly like we want to happen it this time. The resistance value in our LDR-brick decreases with the increasing intensity of ambient light, so the current flow into the base is reduced by help of the voltage divider. The two 100kOhm resistors are high and with the low value of the LDR, in this case, the voltage at the base gets lower than the threshold voltage of 0.7V. Therefore there is no current flow from collector to emitter and the LED is off.

Now when less light falls into the LDR, because it's getting darker in the environment, the voltage divider at the base tries to increase the voltage at the base. Slightly above 0.7V the current flows into the base (only limited by the two 100kOhm resistors). In this case the LED turns on.

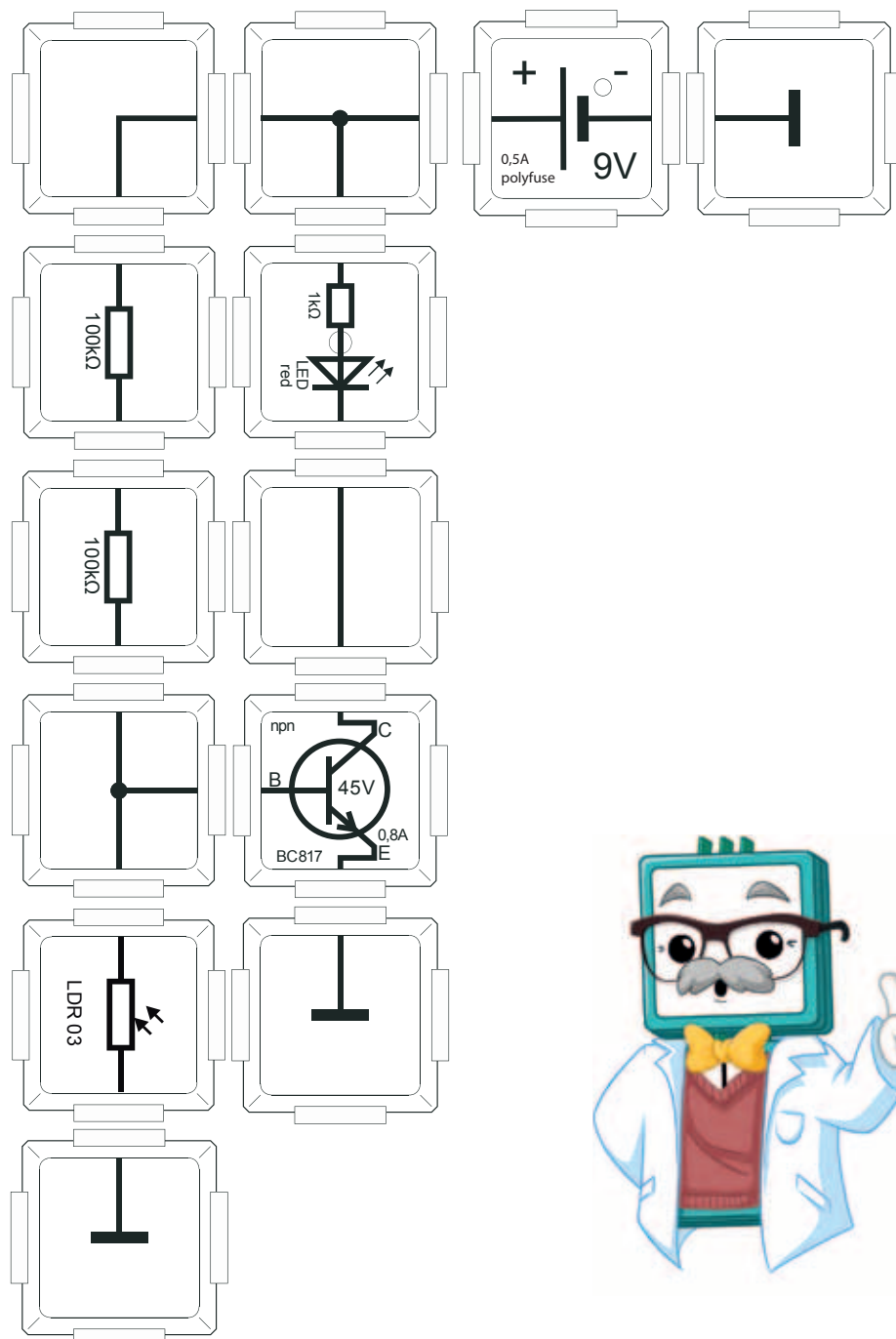

9.6 LED as photodiode

In a LED, light is produced by a recombination of electrons that emit energy in form of a photon, when recombining occurs in the valence band. This process is reversible: electrons are detached from the valence band by photons entering due to ambient light, allowing a very low current flow between the depletion layers. This effect is many times weaker than that of the inverted normal operation of the LED. We can observe this physical process, we need a darlington circuit with two transistors and a very high gain.

The 100k resistor in series with the blue LED is needed to protect the LED against the reverse voltage of the voltage source, which can lead to a breakthrough in the depletion layer. If now the semiconductor of the LED is luminated by a bright light source, a minimal current flow into the base of the first transistor is generated, this triggers the darlington circuit and the red LED lights up.

If the blue LED is dimmed, the darlington amplifier closes and the red LED gets darker.

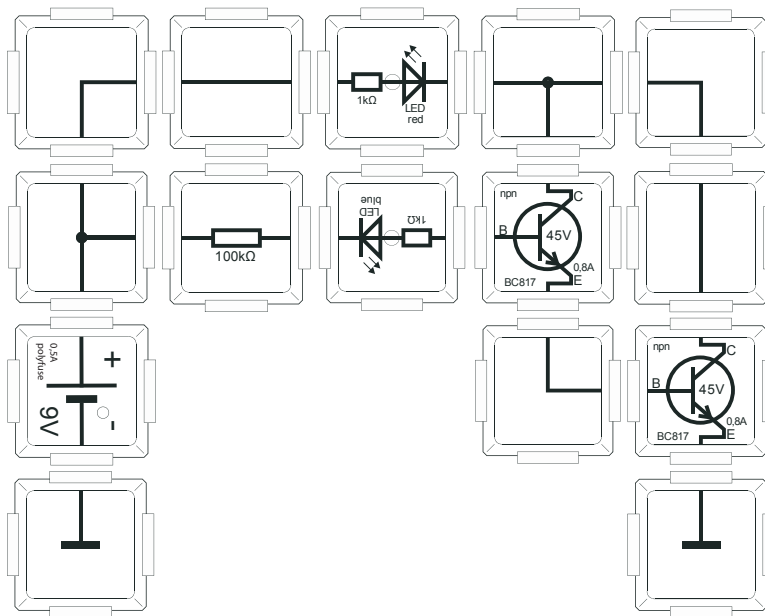

9.7 Transistor as inverter

To implement a dark or twilight circuit, a transistor can be used as an inverter. In this case, the transistor inverts the switching behaviour of the second. If the threshold voltage of the first transistor is reached when the LDR gets light, a current flows between collector and emitter of transistor 1 and the voltage at the collector drops. The collector of transistor 1 is connected via a 10 k Ohm resistor to the base of transistor 2, and the base voltage drops below the 0.7V. The transistor 2 is off and the LED is dark. A current flows between collector and emitter of transistor 1 and the voltage at the collector drops. The collector of transistor 1 is connected via a 10 k Ohm resistor to the base of transistor 2, and the base voltage drops below the 0.7V. The transistor 2 is off and the LED is dark. If the LDR is in darkness, and therefore the threshold at the transistor 1 drops below 0.7V, then the transistor 1 is off. The 1k Ohm resistor now pulls the collector voltage high. Through the 10 kOhm resistor a current can flow into the base of transistor 2 and the LED is getting on.

The threshold level, where the LED starts to light up is set by the potentiometer-brick. The LED lights up permanently, when the wiper is at the left position, the LED diminishes when the wiper is moved to the right position.

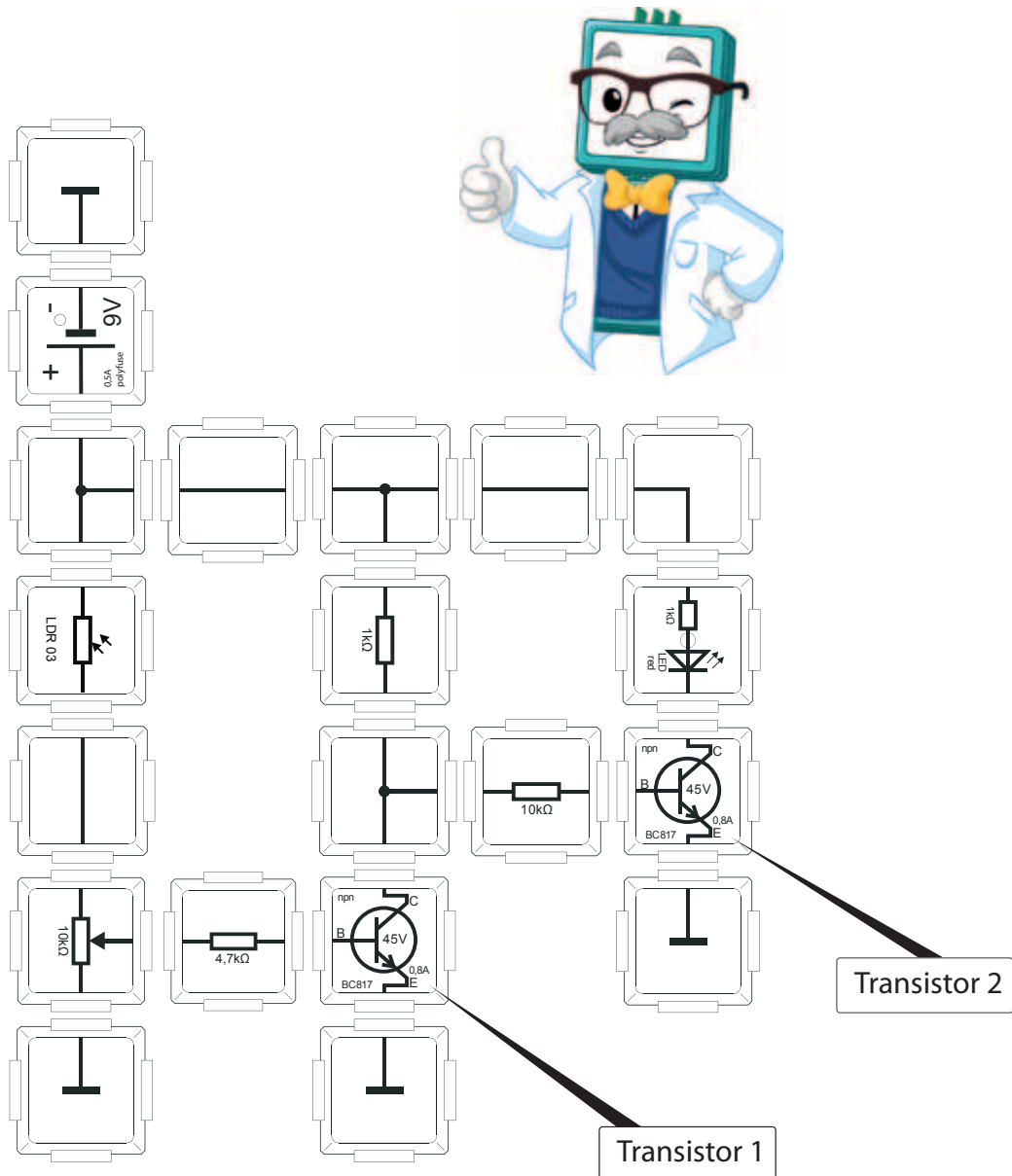

9.8 LED inverted

The inverted logic states are used in industry and technology in many circuits. Here we use two LEDs to demonstrate the inversion behavior of a transistor. If the push button is pressed, then the yellow LED is on and the red LED is off. If the push button is released, the yellow LED is off and the red LED is on.

If the button is pressed a current flows into the yellow LED and also into the base via the 100 k Ohm resistor. The Transistor is activated and current can flow between collector and emitter. The voltage at the collector therefore drops below the threshold voltage of the red LED which diminishes.

If the button is in the release position, the base of the transistor is at the ground level, the transistor is off. The collector now can raise to a high level via the 1 kOhm resistor leading to the voltage source and the red LED is on.

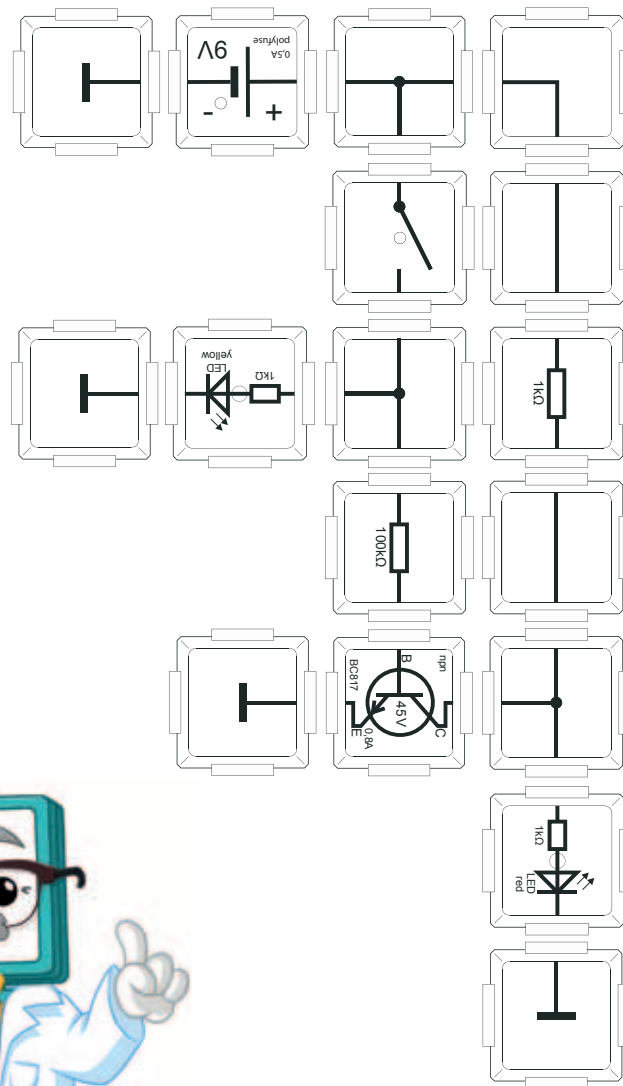

9.9 LED with constant current at 9V supply voltage

Since the voltage drop across diodes (also LEDs) is constant (for around 1.5V for our red LED), they are controlled by the current. Usually LEDs are driven with a constant current to maintain a constant intensity.

To stabilize the current we use a small circuit with a transistor and a so called zener diode. The zener diode can be operated in reverse direction, and has a so called breakdown voltage. This zener voltage is 3.9V for our zener diode.

Now with the 100k Ohm in series we have a voltage of 3.9V at the base of the transistor. Across the base to emitter we have 0.7V drop. This results in 3.2V at the emitter. Now we get into business. The 3.2V is also across the 1k Ohm resistor at the emitter towards ground. This defines the current into the emitter.

$$I = \frac{U_{(z)} - U_{(T)}}{1000\Omega} = \frac{3.9V - 0.7V}{1000\Omega} = 3.2mA.$$

A small current flows into the base (defined by the 100 kOhm resistor), its enough to switch on the transistor. Therefore most of the emitter current flows into the collector. That means the current into the LED is around 3.2 mA.

For experts: ($I_c = I_e - I_b = I_e - I_b$, $I_b = \text{around } (9V - 3.9V) / 100000$, where $I_b * \text{gain} \gg I_e$).

It is important to ensure that the zener diode is reverse biased. It is named after the Zener effect, that was described by american scientist Clarence Zener for the first time. He found out, that electrons can tunnel through the semiconductor layers in the reverse direction, when their enhancement with positive and negative charge carriers is very high. Zener diodes have a specific Z-voltage, depending on their production method. Our zener diode has a Zener voltage of 3.9 volts. The next experiment 9.10 deals with their constancy.

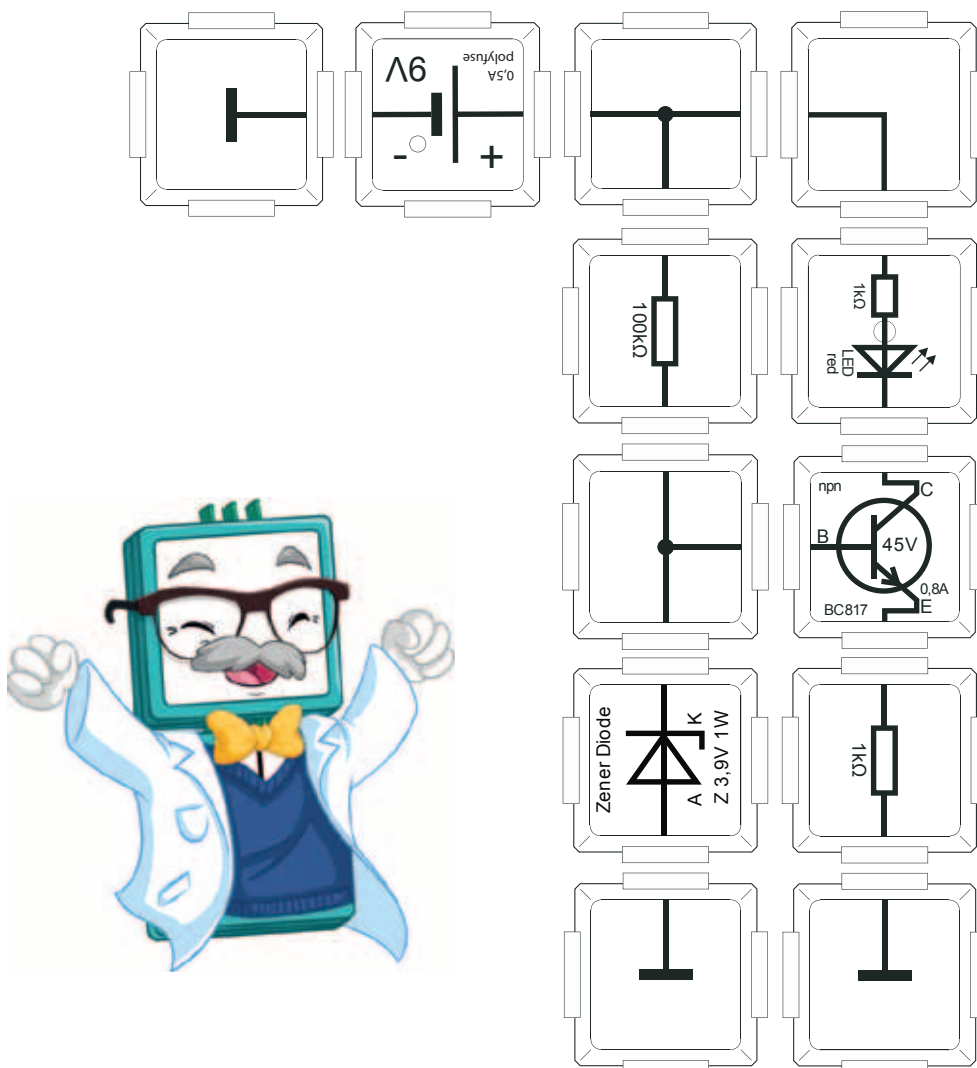

9.10 LED with constant current and 18V supply change

To check if the flow through the LED remains constant, we increase the supply voltage to 18V. We achieve this through a series connection of power-supply- and battery-brick. In this experiment it's extremely important to check the correct polarity! The negative port of the battery-brick has to be connected to the positive port of the power-supply-brick.

The light intensity of the red LED at the collector of the transistor remains nearly the same!

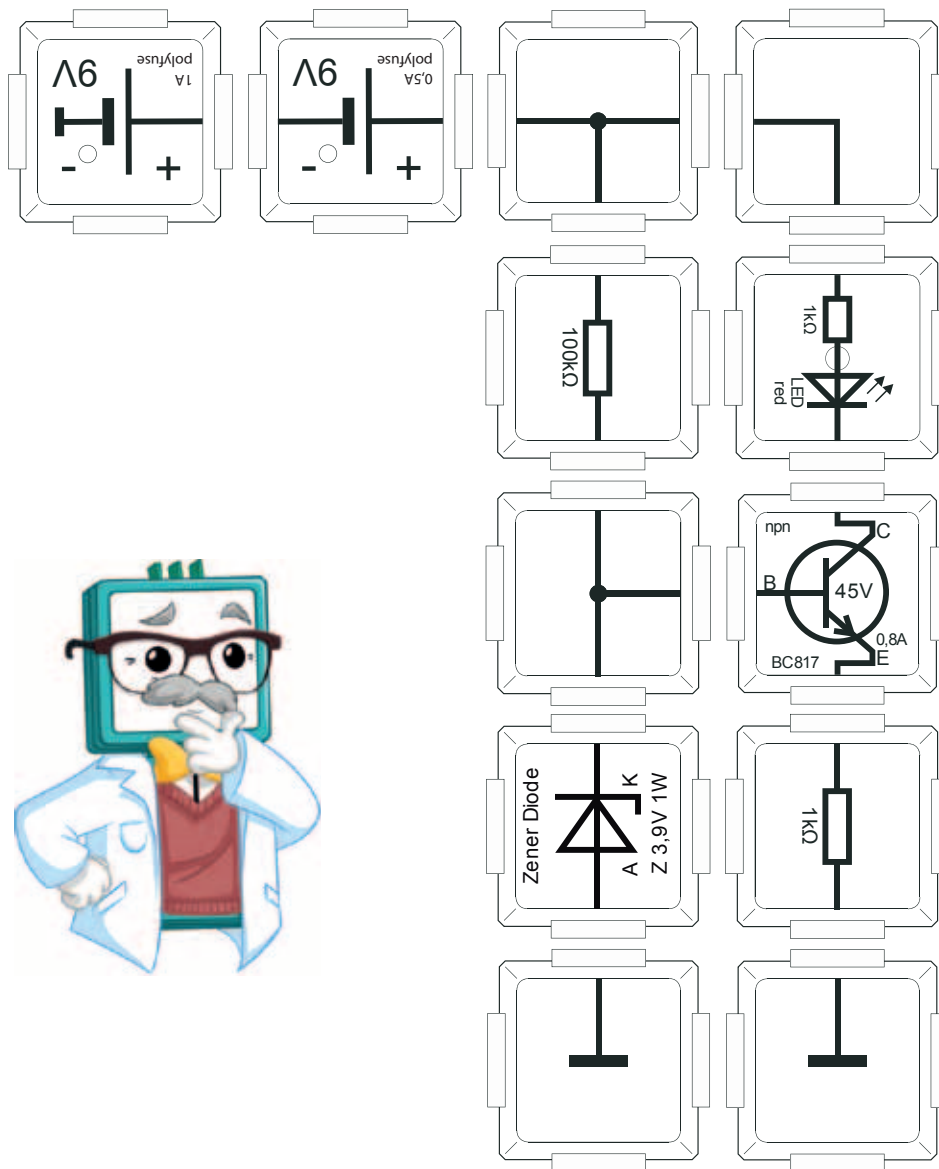

9.11 Astable multivibrator

A classic circuit for generating a square wave oscillation. Two transistors are used in the circuit with always one in on and the other in off condition. Two capacitors and two resistors are used to define the total cycle of the oscillation. The transistors are used for charging and discharging the capacitors.

This type of circuit is called astable multivibrator, in our circuit the astable operation is shown by the blinking LEDs, when the frequency is low enough. The period can be roughly calculated:

$$T = 2 * \ln(2) * R * C = 2 * \ln(2) * 100k\Omega * 10\mu F = 1.39s$$

The Advanced set includes capacitor- and resistor-bricks with different values. In this example the value of the bricks can be changed to manipulate the frequency. The left resistor and the upper capacitor control the switching behavior of the left transistor and reverse. If the resistor and capacitor are not equal at both sides, an asymmetric pulse duration is achieved. It is not possible to allow the circuit to remain in a stable state, that's why its also called astable.

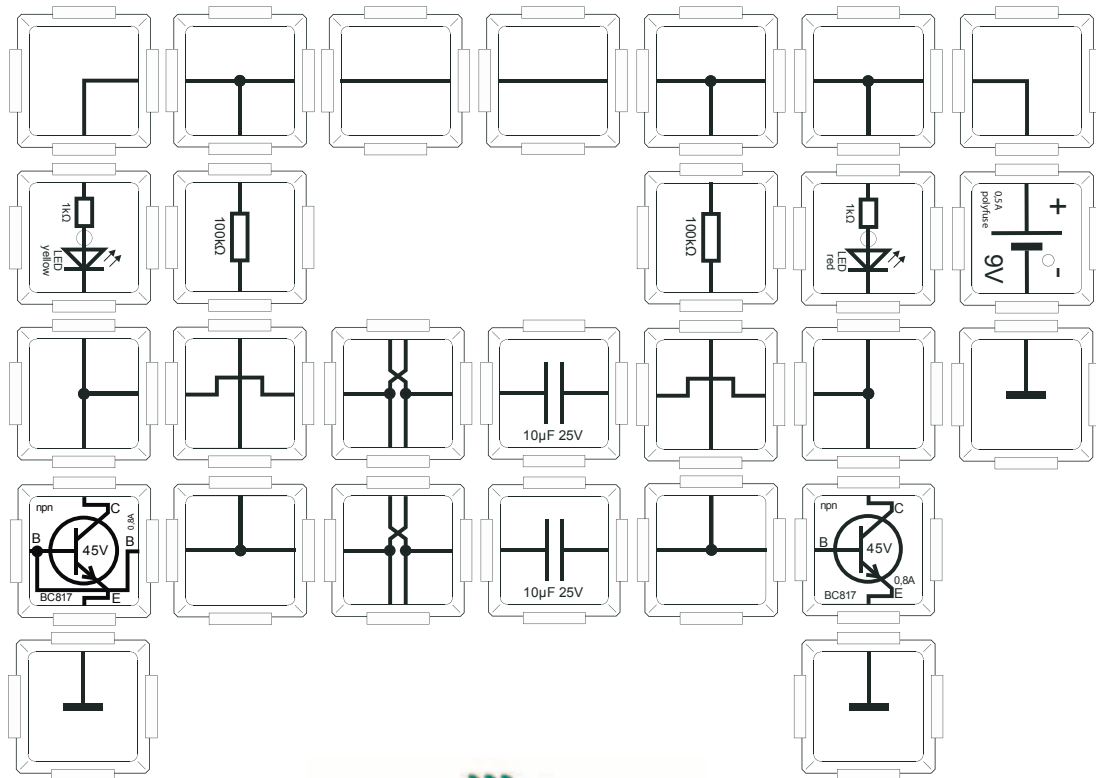

9.12 Monostable multivibrator

In contrast to chapter 9.11 one of the transistors needs an additional resistor instead of the capacitor at its base side to operate as monostable multivibrator. In addition to that a push button is inserted in the circuit between base of the first transistor and its resistor. A monostable multivibrator knows exactly one state where he remains. This occurs, everytime the circuit has cycled. The left transistor is dominant, because it is no longer controlled by a capacitor, but directly via a push-button. When the push button is not pressed, the red LED lights up. If the button is pressed, the yellow LED lights up and the red gets off. When the push button is released immediately, the yellow LED lights up for a short time, and the red one remains dark at this time. Holding down the button for longer time, the yellow LED lights up until the button is released. At the same time the red LED remains dark until the time defined by the capacitor has expired.

Now the stable state is reached and the red LED lights up permanently. By pressing the push button repeatedly pulses can be created, this is called triggering. Trigger signals are used to generate pulses.

Attention: The red is glowing also in the off condition as a small amount of current flows through the 10 kOhm resistor into the base of the first transistor which is enough.

This example is perfect for experimenting! You can use a lot of different bricks, for changing some effects.

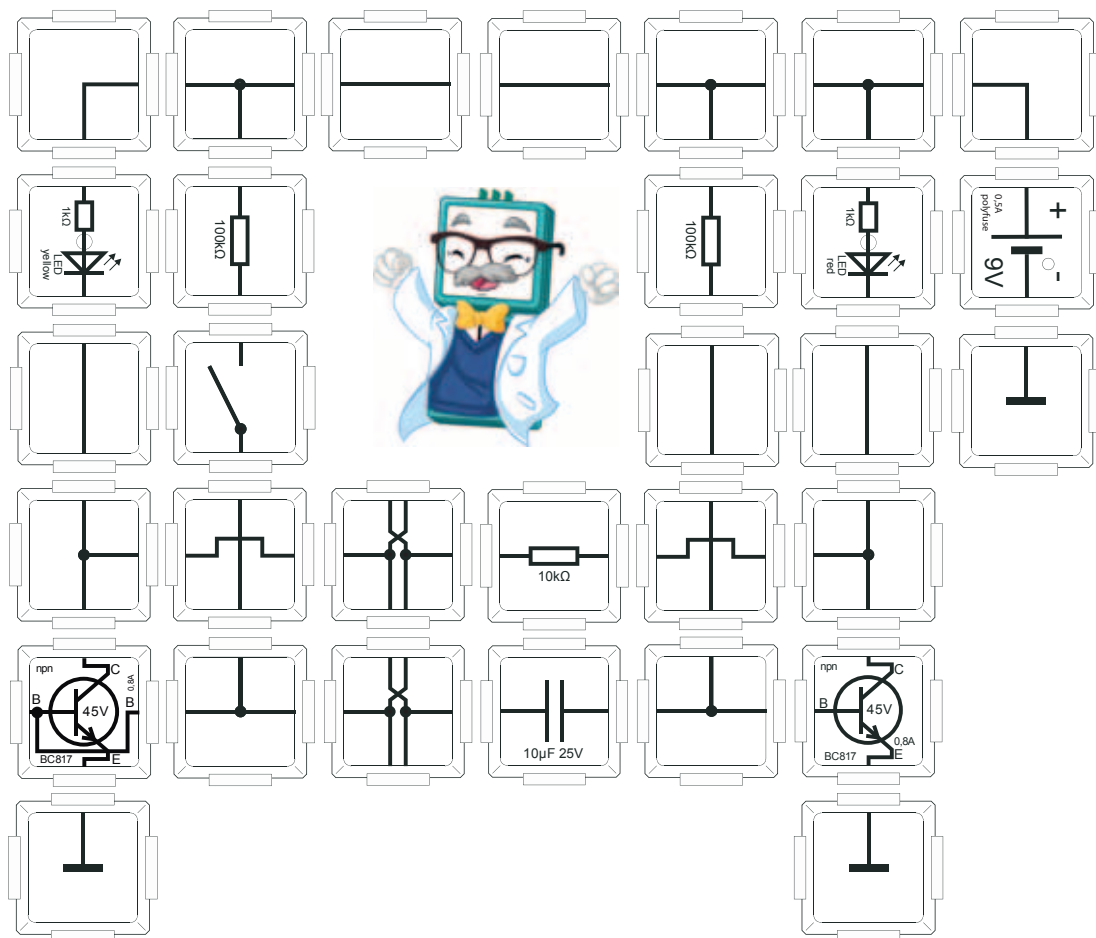

9.13 Bistable multivibrator

To obtain a bistable flip-flop some changes have to be done, compared to example 9.11. The resistors have to be replaced by two push buttons and the capacitors in the transistor-base paths are replaced by two 100kΩ resistors.

Bipolar flip-flops are controlled by two triggers and provide two opposite output signals. These circuits are also used to store data. This example contains two push buttons as trigger. By pressing the right button, the yellow LED lights up and the red LED turns off. By pressing the left button, the red LED lights up and the yellow LED turns off. Each trigger controls both output signals exactly in the opposite way.

These circuits are also called flip-flop. When no push button is pressed, the LED switched on at last, remains on. This event is stored until a new pulse triggers the circuit. These R/S flip-flop circuits (Reset/Set) are mainly used in automation applications. Their main advantage compared to other circuits is that the trigger signal does not need to be present continuously. A small impulse is enough to open the garage door. The door opens until the stop position is reached and the door automatically stops at the desired position. The door remains in that state as long as a new impulse is sent.

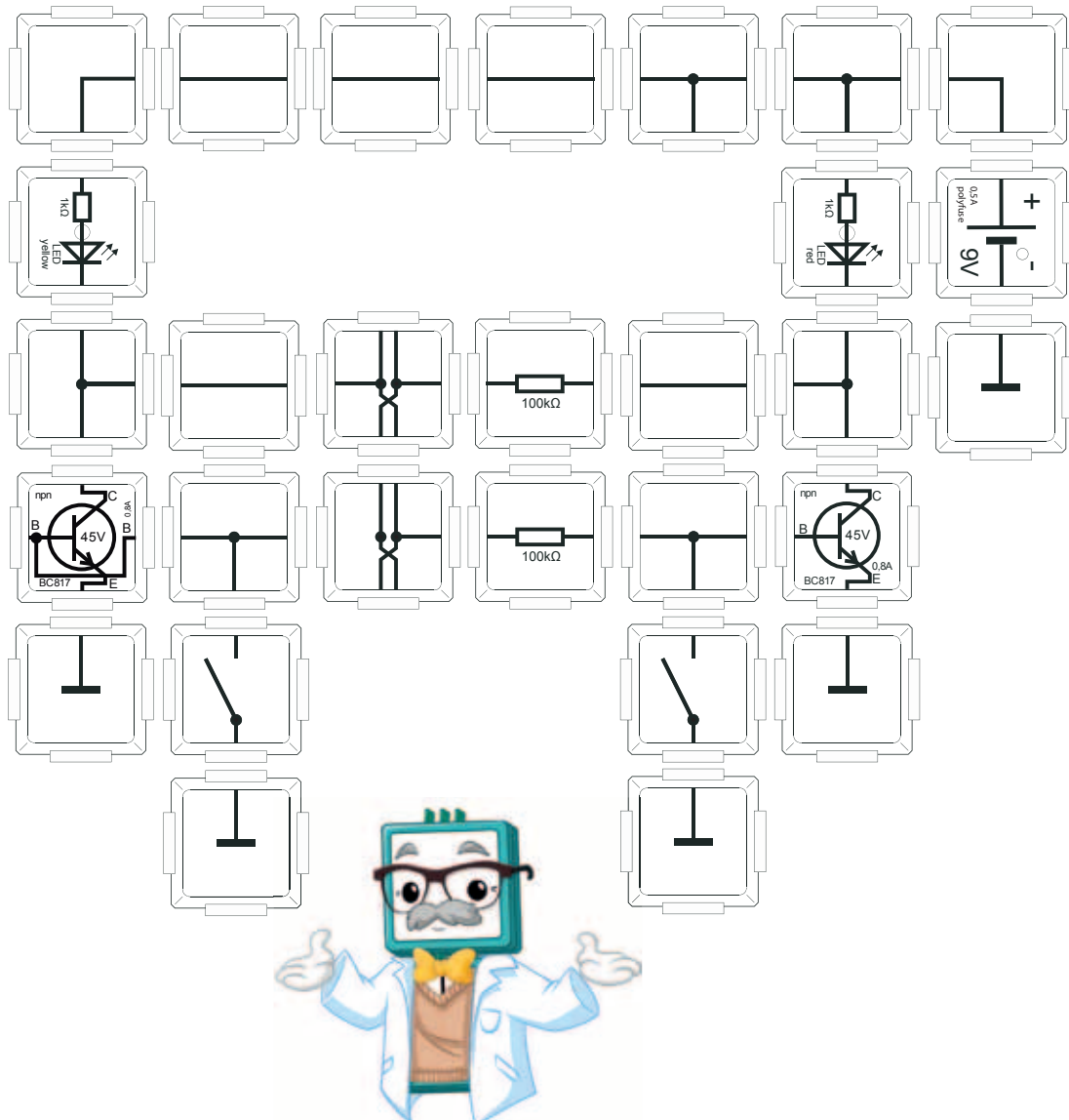

10. JFET - Junction Field Effect Transistor

10.1 J310-n-channel JFET

JFET stands for Junction Field Effect Transistor with a connected gate. In this experiment, the n-channel JFET J310 is used. Field effect transistors use negative voltage at a gate terminal to control the current flow between its drain and source contacts. If the gate voltage is 0V, the FET acts like a normal ohmic resistor, so that there is no influence of the current between drain and source port. The control gate voltage must be negative, because positive gate voltage will produce an unwanted current flow. That's why we used here two voltage sources connected with a common ground Minus for one and at Plus for the other. They define a voltage range from -9V to +9V. However, the reference potential is ground (0V). To prevent an unacceptably high gate current, a 100kΩ resistor is connected in series with the gate contact. The potentiometer now controls indirectly the current flow to the red LED. If the wiper is at right position, the JFET stops current flow, because the drain-source path gets a too high impedance. If the wiper is at left position, the current flow between source and drain occurs and the red LED can light up at maximum intensity.

The JFET J310 used in this experiment is usually used in high frequency pre-amplifiers or LNAs (low noise amplifier) to ensure a good signal quality.

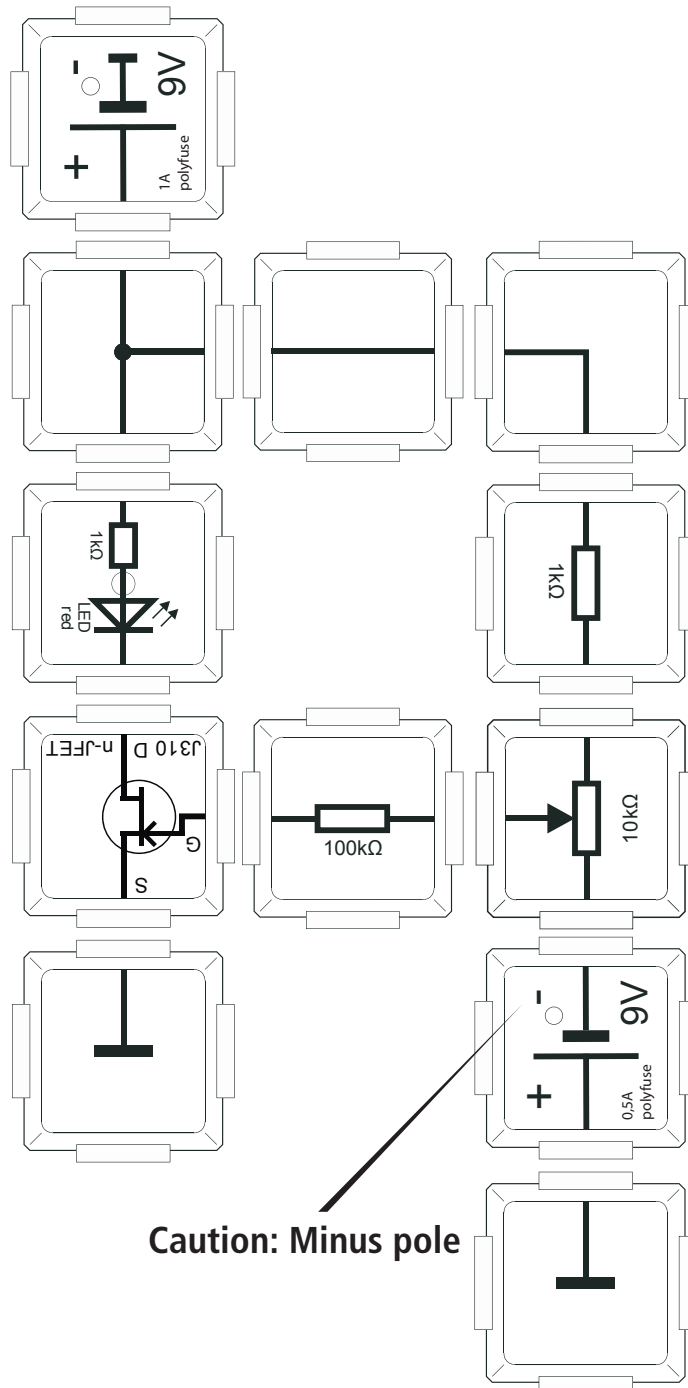

11. MOSFET

11.1 MOSFET functions

A Metal-Oxide-Semiconductor Field Effect Transistor (MOSFET) has a very high ohmic resistance at its gate contact. The gate voltage creates an electrical field, like capacitors do, wherein the underlying channel between source and drain become conductive. With the high gate resistance only an electric field is built to control the current flow. In opposite to this a bipolar transistor like the BC817 needs a current flow to control its behavior. The circuit symbol illustrates this by the separation of the gate from source and drain port. There are different types of MOSFET's available. They are distinguished by n- or p-channels, as well as self conductive or non self conductive. Our MOSFET is a non-conducting n-channel transistor. This is also indicated by the circuit symbol, because the line between source and drain is interrupted. This stands for non-conductive, the arrow pointing inwards identifies the n-channel.

Our MOSFET allows a current flow, when a positive gate-voltage is applied, otherwise it is at high impedance. In the following example the voltage at the gate is defined by the potentiometer. When the potentiometer wiper is moved from left to right, the MOSFET becomes conductive and the red LED lights up.

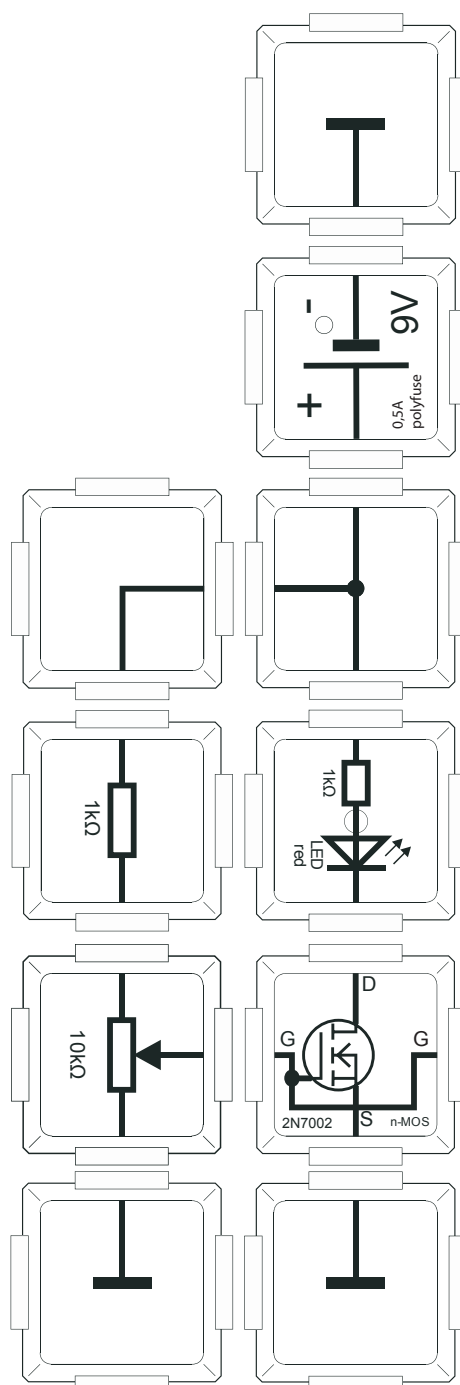

11.2 MOSFET as switch

The MOSFET can, like the BC817, also be used like a switch. The large resistance values of the voltage divider at the gate contact allows a small current flow to the ground when the button is pressed. In this case only half of the voltage is available at the gate, due to the voltage divider (100k + 100k). This is sufficient to switch on the MOSFET and therefore the LED. When the button is released, the gate is connected to ground via the 100k Ohm Resistor and therefore turns it off. Also the LED is then in a off state.

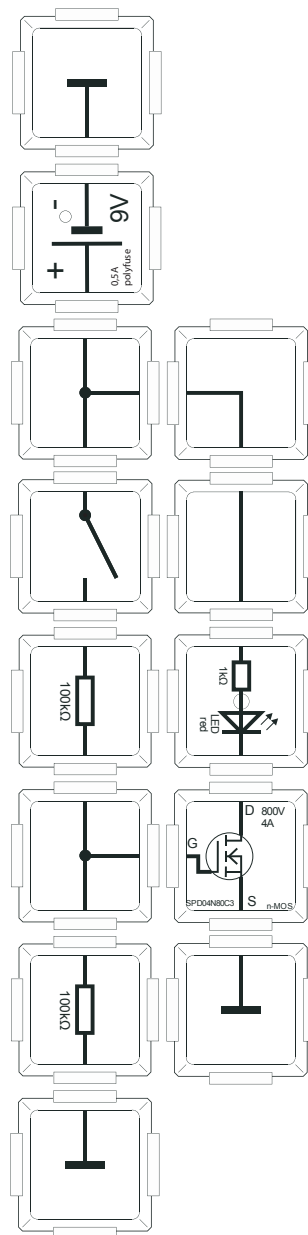

11.3 Simple NMOS touch sensor

This example is a series circuit built of a voltage source, a LED, the MOSFET and two ground bricks to close the circuit loop. The MOSFET is so highly sensitive, that it can be activated simply by touching the contact. Here the lowest charge volumes that surround us everywhere are enough to cause a switching operation of the MOSFET. The charge results from the normal power line, or are static and build up a potential difference to our MOSFET. The MOSFET can be destroyed by a simple spark, so be carefully when touching the MOSFET!. To avoid damage, please contact the battery-brick before touching the gate contact do avoid static charge. If the LED turns off after releasing the contact, the experiment can be started again. However, if the red LED stays on, like using a capacitor, the LED turns off, when the stored charge flows away.

Note: Please be absolutely careful with the MOSFET, because it can be destroyed very easily by static electricity.

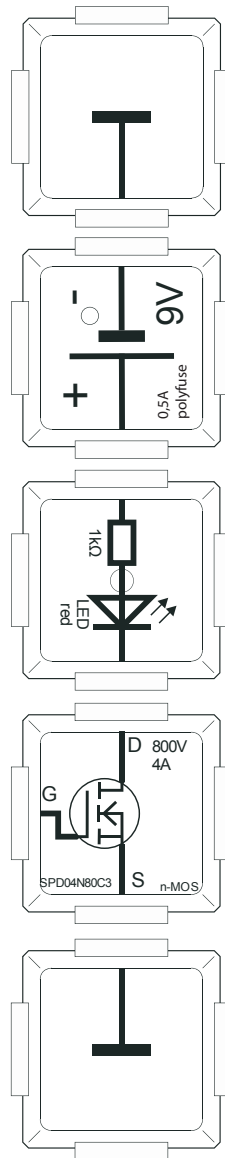

12. Special semiconductors

12.1 PUT - Programmable Unijunction Transistor

PUT stands for Programmable Unijunction Transistor. It has three terminals, the anode, cathode and the gate. Connected in forward direction, it behaves like a diode with a high threshold voltage, when connected in reverse direction no current flows. The threshold voltage can be manipulated by applying positive voltage at the gate contact. That's why the PUT is also called programmable. PUTs are also used for building oscillators. Parallel to the PUT a capacitor is used in the circuit. It is charged from the voltage source until the threshold voltage is reached. After reaching the threshold the capacitor discharges via PUT and the red LED. Now the charging process can start again through the battery. Now the PUT oscillates at a certain frequency.

This is possible because the voltage can decrease after reaching the threshold and the PUT remains conductive until almost 0V are reached. In our circuit the threshold is set by the potentiometer, the red LED blinks with increasing frequency, when the wiper is turned counterclockwise.

For the curious: The frequency at center position of the potentiometer can be calculated the following way:

$$f = \frac{1}{R * C * (\ln(\frac{1}{1-\eta}))}$$

$$= \frac{1}{100k\Omega * 10\mu F (\ln 2.61)} = \text{ca. } \mathbf{1.04Hz}$$

$$\eta = \frac{5k\Omega + 4,7k\Omega}{4.7k\Omega + 10k\Omega + 1k\Omega}$$

$$\eta = \text{about } 0.617$$

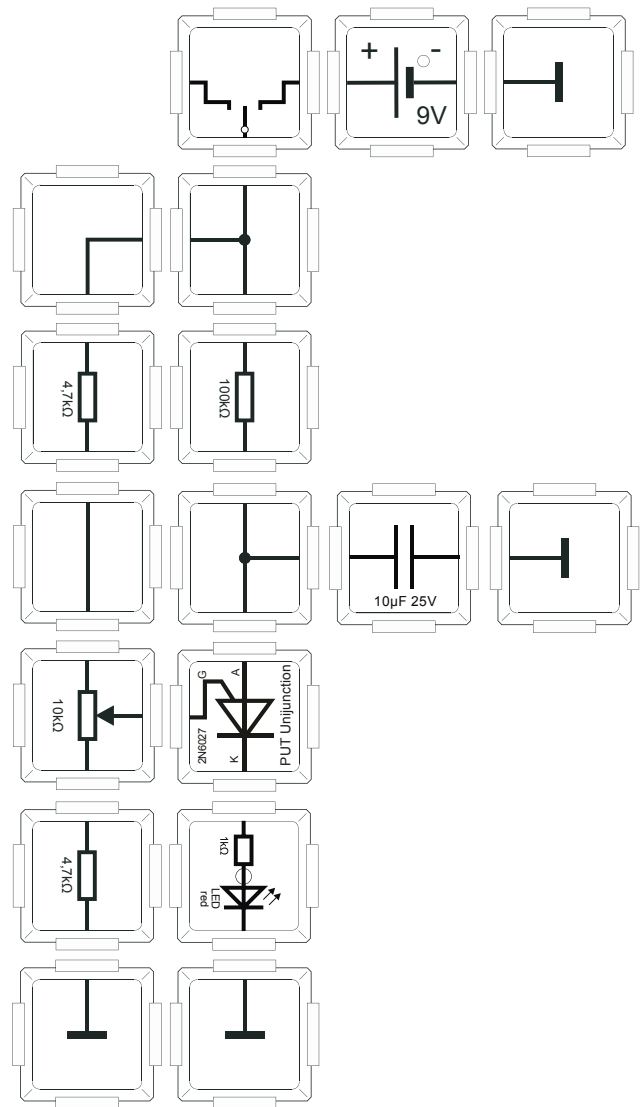

12.2 Thyristor in the equivalent circuit diagramm

Further electronic components with special properties, such as high current capability, are the Thyristor and TRIAC. The thyristor also requires a positive ignition voltage to be activated, similar to the control voltage at the PUT, but remains conductive, until it will be cleared.

When applying AC voltage to the gate contact, the thyristor will be cleared and are ignited in a continuous way. The AC signal is called phase control. This will be applied to the gate contact in order to allow a current flow between anode and cathode. The TRIAC can handle both, positive and negative ignition voltages on gate contact and is conductive in both directions between the main contacts. This is often used in AC technology.

This can be used to dimm the brightness of a AC powered light source, nearly without loosing energy.

In this example we have set up a circuit emulating a thyristor by using two opposite transistors, a NPN and a PNP version. When the supply voltage is applied by using the switch S1, the thyristor is activated by pressing the switch S2 and the red LED will light up. Now the LED can only be switched off by interrupting the supply voltage, then the thyristor is cleared.

This experiment can be repeated unlimited.

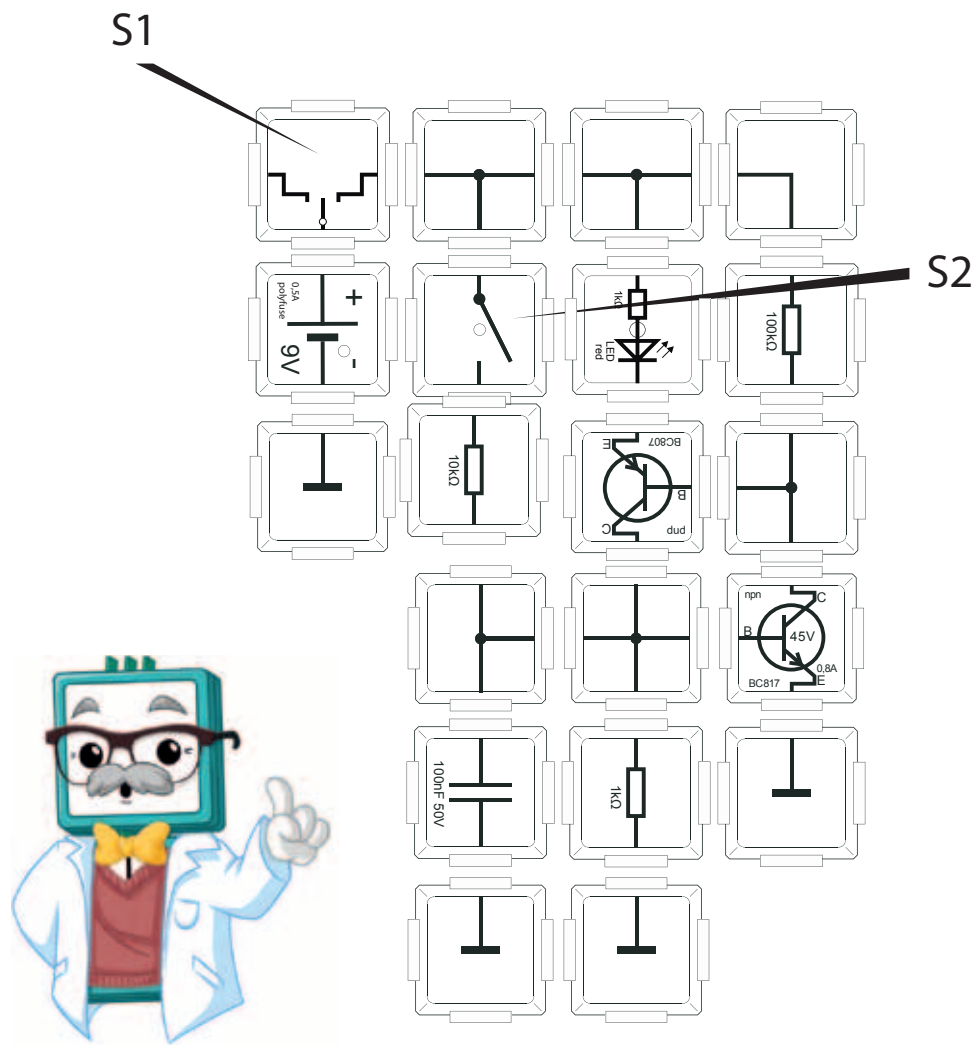

13. Timer 555

The timer 555 is an integrated circuit that is used for time-dependent control. The integrated circuit can be used for a wide range of tasks.

13.1 Timer astable

The classic oscillator! With the use of two resistors a 10kOhm and a 100kOhm resistor and a capacitor of 10uF the 555 can control its output oscillation with an amplitude ranging from 0V to the maximum power supply voltage. During charging of the capacitor via the two resistors, the timer 555 provides supply voltage at the output. If the capacitor is charged, the discharging process starts via the 100kOhm resistor. When the capacitor is discharged completely, the process starts again. The oscillation generated is a square signal, because the timer 555 switches between supply voltage and ground. The red LED flashes as long as the timer 555 is connected to the power-supply, that's why this mode is called astable. The lighting period is 10 percent higher than the dark phase of the LED. Both phases together determine the period.

The time period can be calculated the following:

$$T = (R_1 + 2 * R_2) * C * \ln(2) = (10k\Omega + 2 * 100k\Omega) * 10\mu F * \ln(2) = ca. 1.5s$$

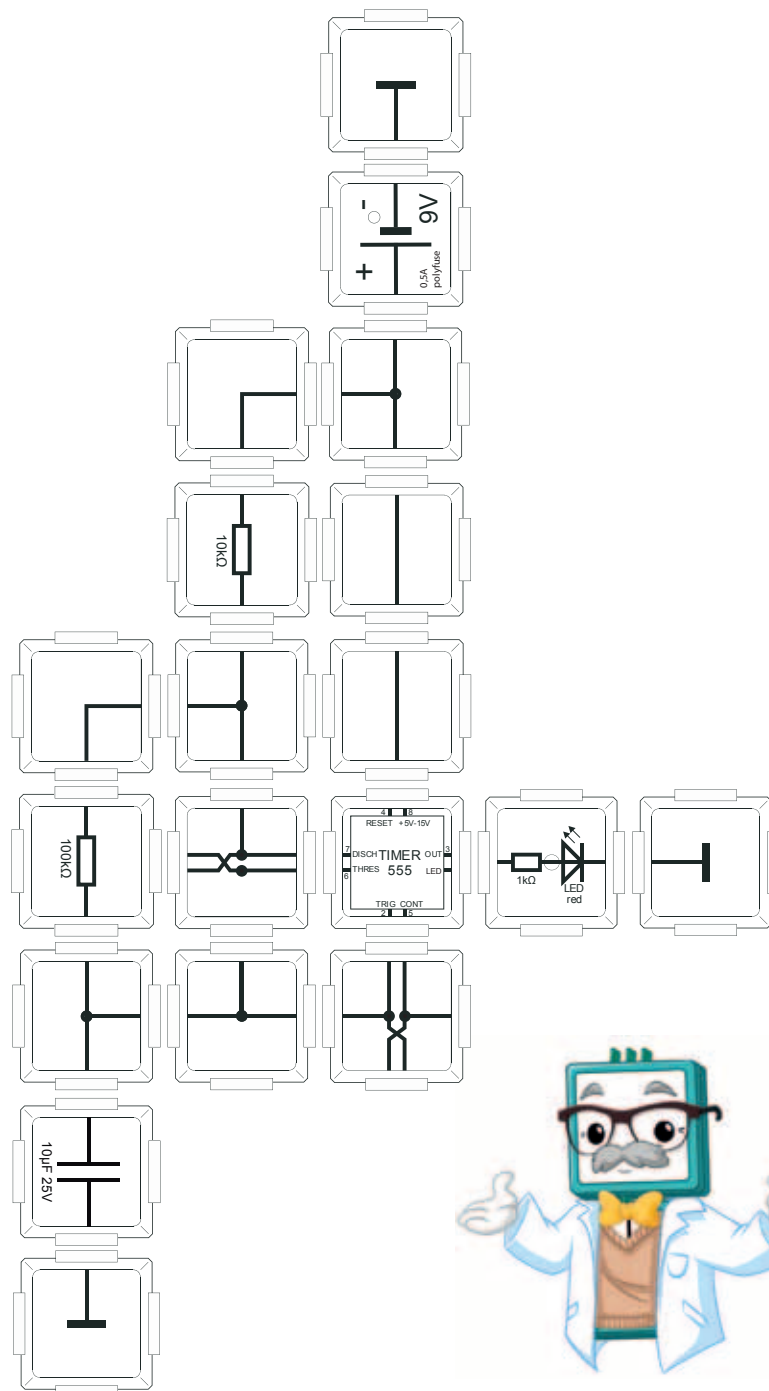

13.2 Timer monostabil

With the timer-brick it is easy to implement a monostable multivibrator. After pressing the button, the red LED lights up until the capacitor has reached the trigger threshold of the timer. Pressing the button for a longer time, the red LED will stay on until the button is released.

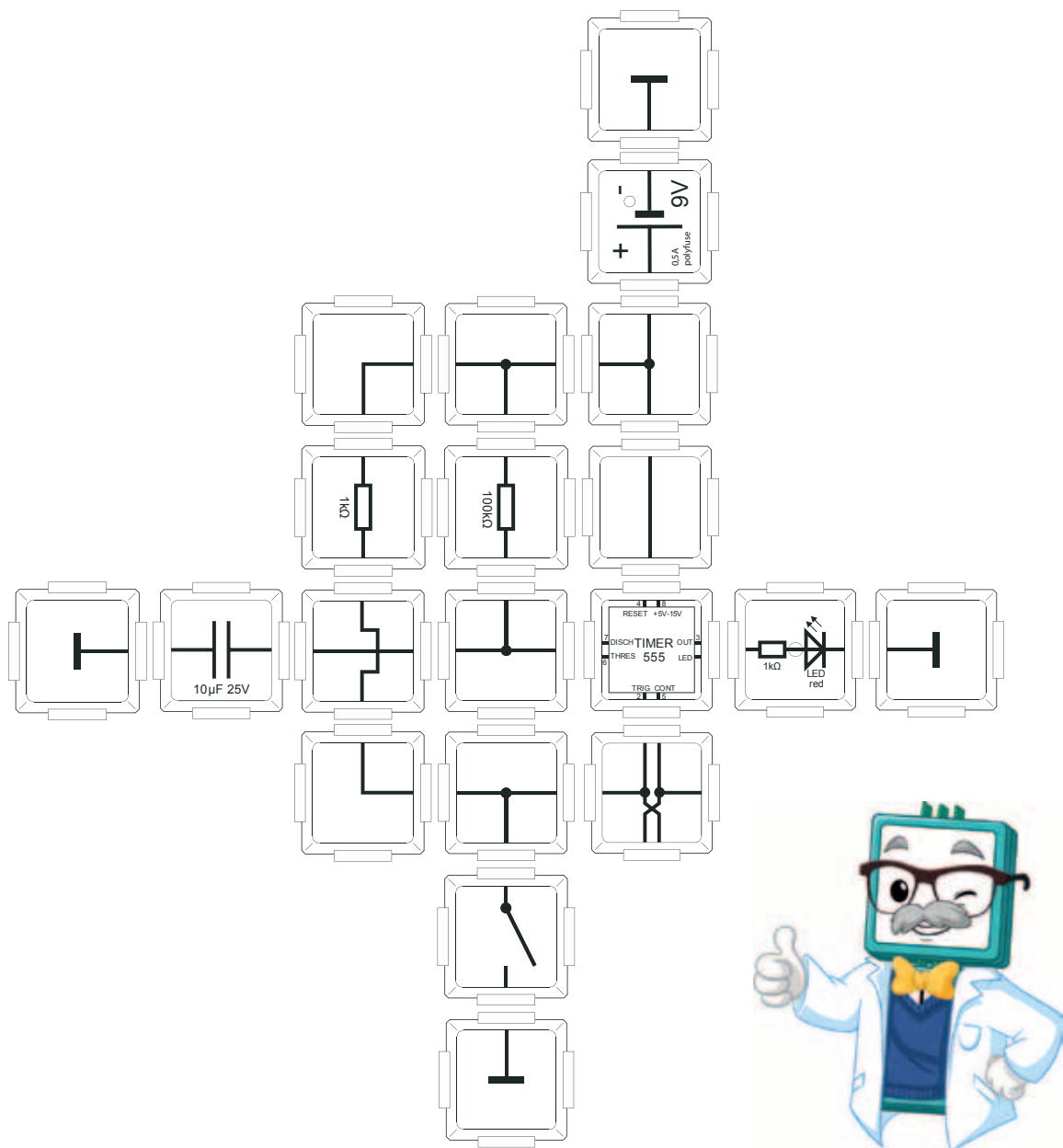

13.3 Timer bistabil

In this experiment we use the timer 555-brick as a flip-flop to control the output signal. The signal remains active until another input is activated. The right button, underneath the 100kΩ resistor is used to light up the red LED. If the contact is disconnected, the LED continues to be on. The LED can be switched off, by pressing the other push button. The signal is now reset and retained, until an different input is made. To reset, the so called threshold input is used.

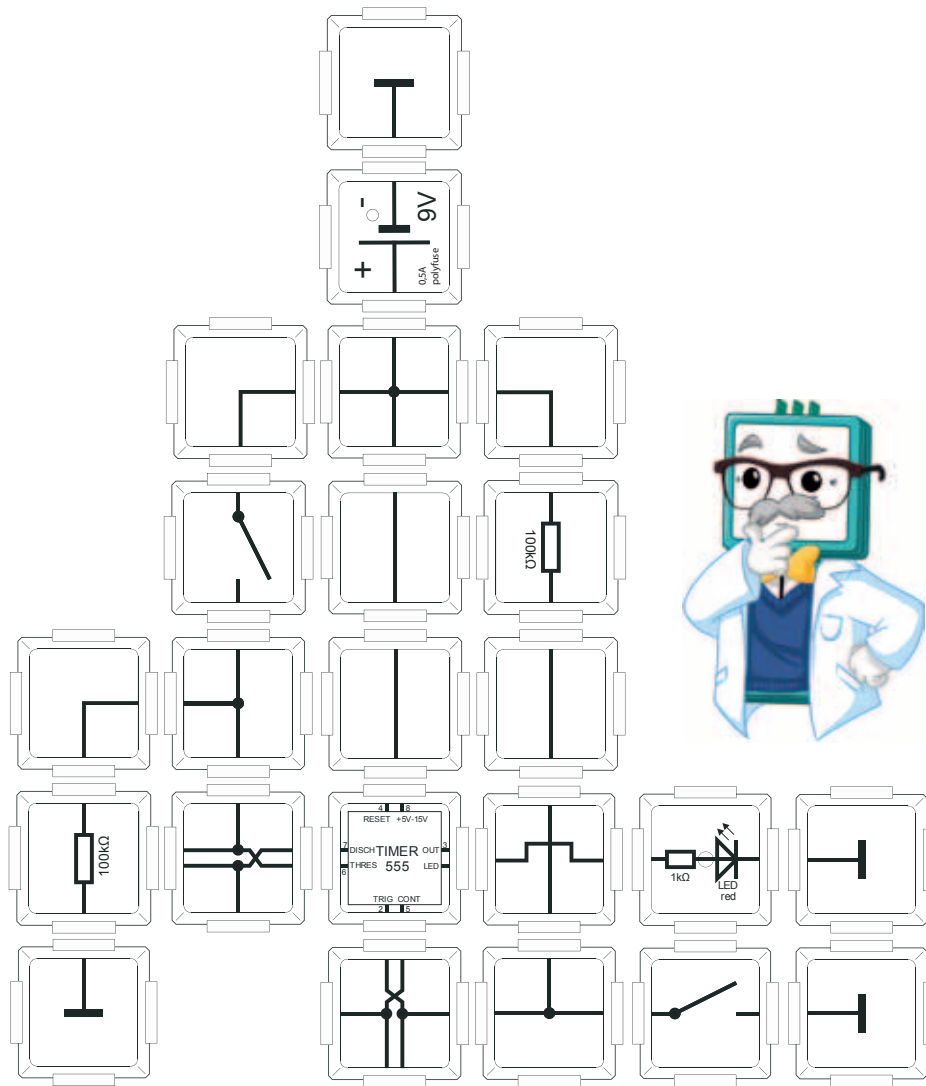

13.4 Timer 555 bistable - alternative 1

This example of a flip-flop circuit is made without additional electrical bricks. You can set the SET-signal directly to the trigger input. Here a switching of the output voltage occurs, when the voltage at the trigger input falls below 1/3 of the supply voltage. The SET-signal is reset, when the reset input is connected to ground. When pressing the upper left push button, the red LED turns off. All states are stored to the state of the beginning until an alternative input is done.

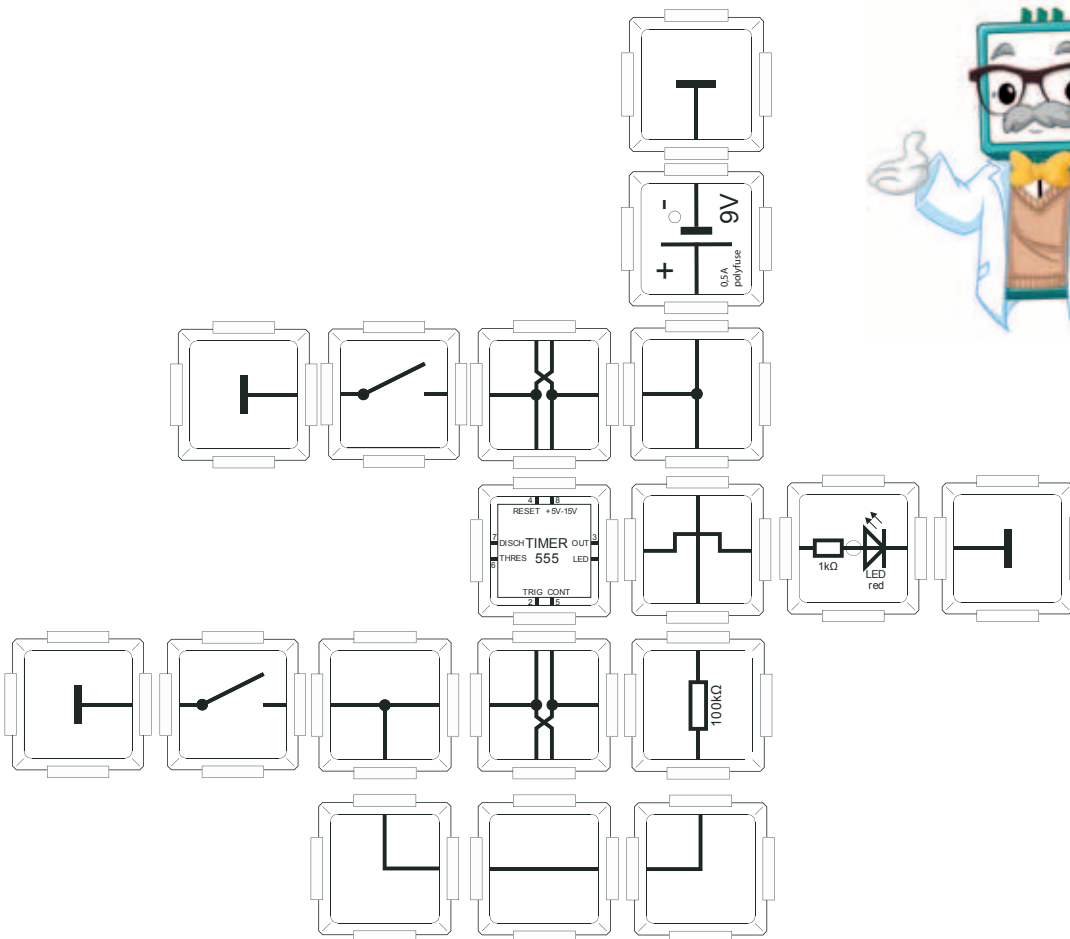

13.5 Timer 555 bistable - alternative 2

The timer 555-brick can also be connected in a different way, by maintaining its flip-flop functionality. Resetting can be done by using the reset-input instead of the threshold-input. The red LED turns off, when the left push button is pressed. Again all signals at the output remain stored, until an alternative input is made. Its not important which type of switch element is used. In addition to the buttons used in this experiment, also MOSFETs and other electronic switching elements can be used in the circuit.

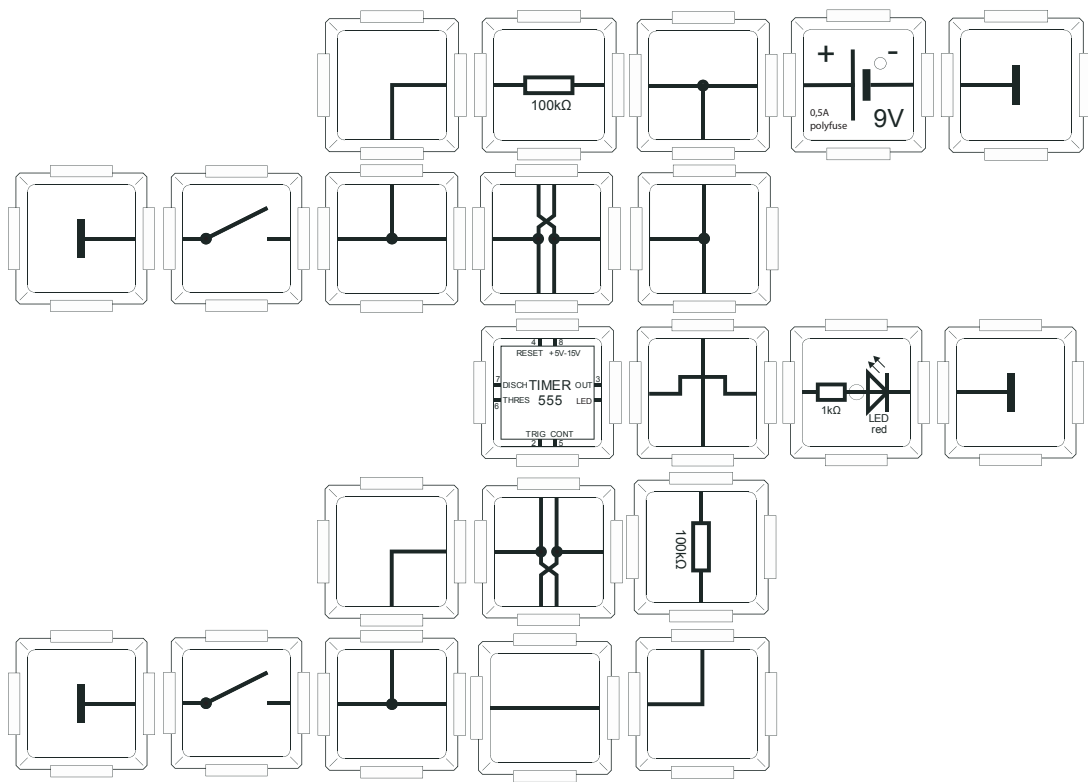

13.6 Timer 555 as voltage generator

Caution: Do not use the power supply brick connected to the power outlet for this experiment!

Caution: The transistor can produce health-hazardous voltages. The gas discharge lamp is used to limit the maximum voltage. So please do not disconnect the lamp, while the circuit is active.

The timer 555-brick specifies the frequency, which is used by the transistor to charge and discharge the coil. The output of the timer switches the transistor on and off. Since the change of the current flow takes place in a very short time, the inductive voltage is very high. The switching frequency of 670Hz is too high to be seen by the naked eye. The gas discharge lamp is connected to a capacitor which is charged by use of a rectifier diode. The capacitor is necessary, because the single event of the coil inductance does not carries enough energy to light the gas discharge lamp. It stores the energy until the ignition voltage of approx. 60V is reached.

After ignition, the capacitor is discharged and the process starts again. The interesting thing about this circuit is that it can produce a higher voltage than provided by the power-supply. Increasing the voltage by a combination of coil and capacitor is used in fluorescent tubes or backlight TFT or LCD screens. This circuit is also called upconverter (boost converter) or booster (amplifier) and is used in transformers or switching power supplies, used for computers. The stabilization of the output voltage is very important and is done in this experiment by the glow-lamp. With the capacitor at the input of the timer 555-brick the switching frequency can be changed. The relationship between resistance and capacitor defines the frequency as shown already in experiment 13.1

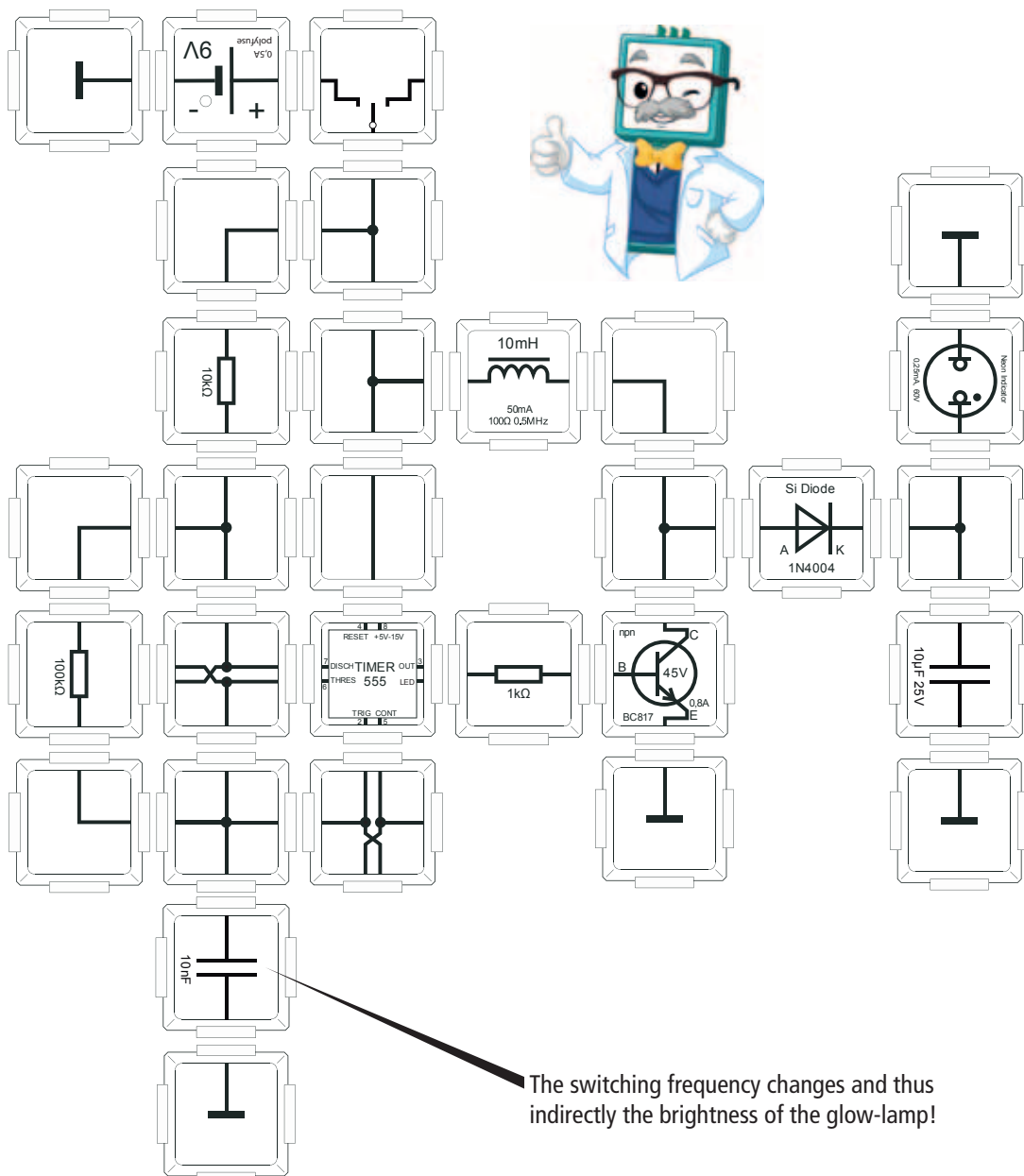

14. Logic circuits

14.1 AND with diodes

An AND operation is implemented with diodes. At the beginning of computer technology switching states have been done with diodes on DTL-way (Diode-Transistor-Logic) and not with transistors only. The AND and OR operations can be implemented easily. If both switches open, the current flows through the diodes in forward direction, the voltage drop is not high enough to let the LED light up. In this circuit it does not matter which button is closed. As long as the diode remains open, the voltage drop is maintained. Only when both switches are closed, both cathodes of both diodes are connected to +9V, and become non conductive and the red LED will light up via the 10kΩ resistor.

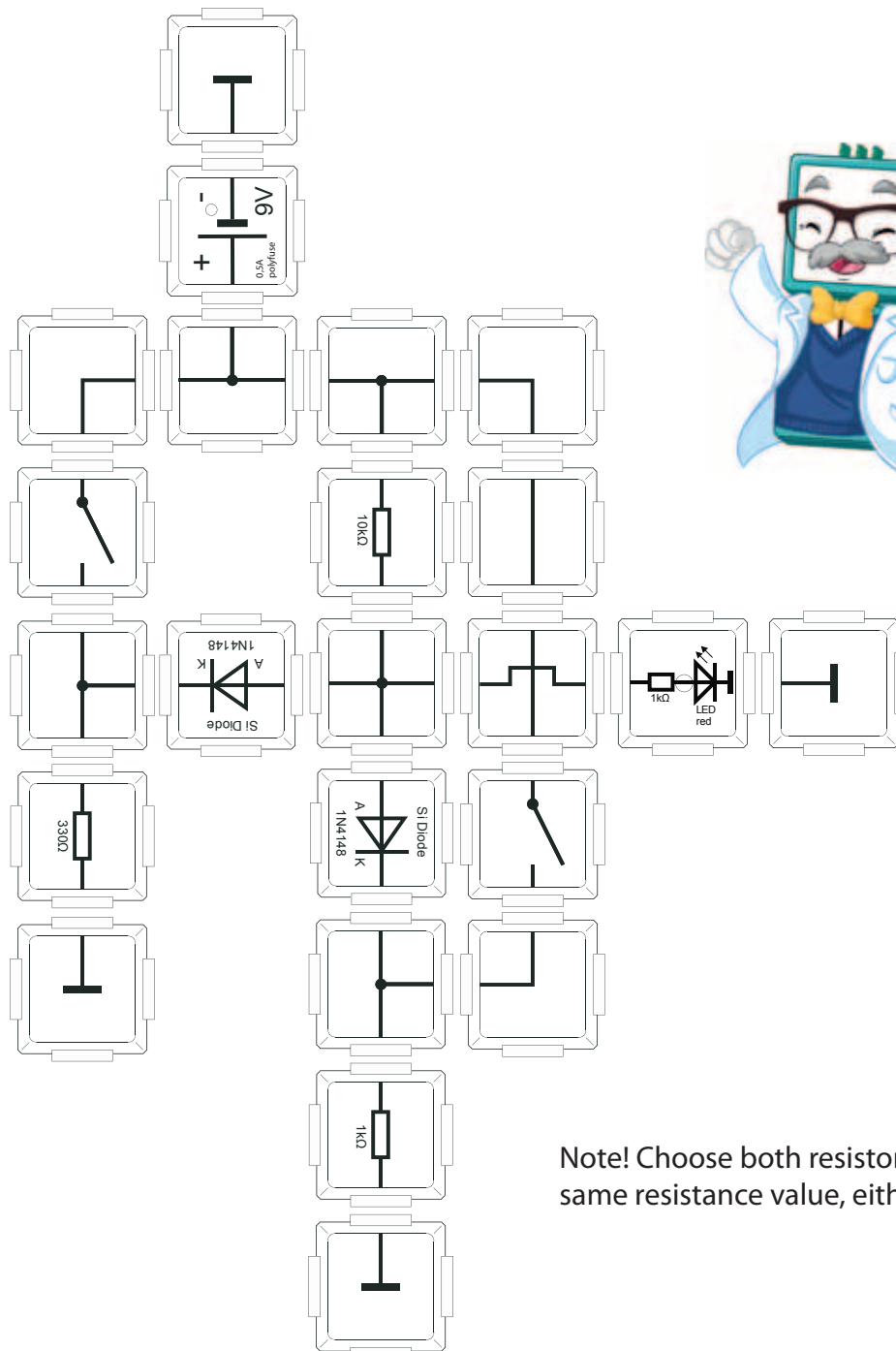

Note! Choose both resistors with the same resistance value, either 330Ω or 1kΩ

14.2 OR with diodes

Its also easy to implement an OR circuit. This is even easier to understand, than the previous AND circuit. We just need to move a few bricks.

These circuits can be problematic, because the output voltage (level) are no longer compatible, when combined with additional follow up logic functions. Additional transistors can solve the problem. They amplify the output signal again and a DTL (Diode-Transistor-Logic) will result. In the following circuit it does not matter which push button is pressed. The red LED lights up always when one or the other or both buttons are pressed. If no button is pressed, the LED is off. This is a simple OR function.

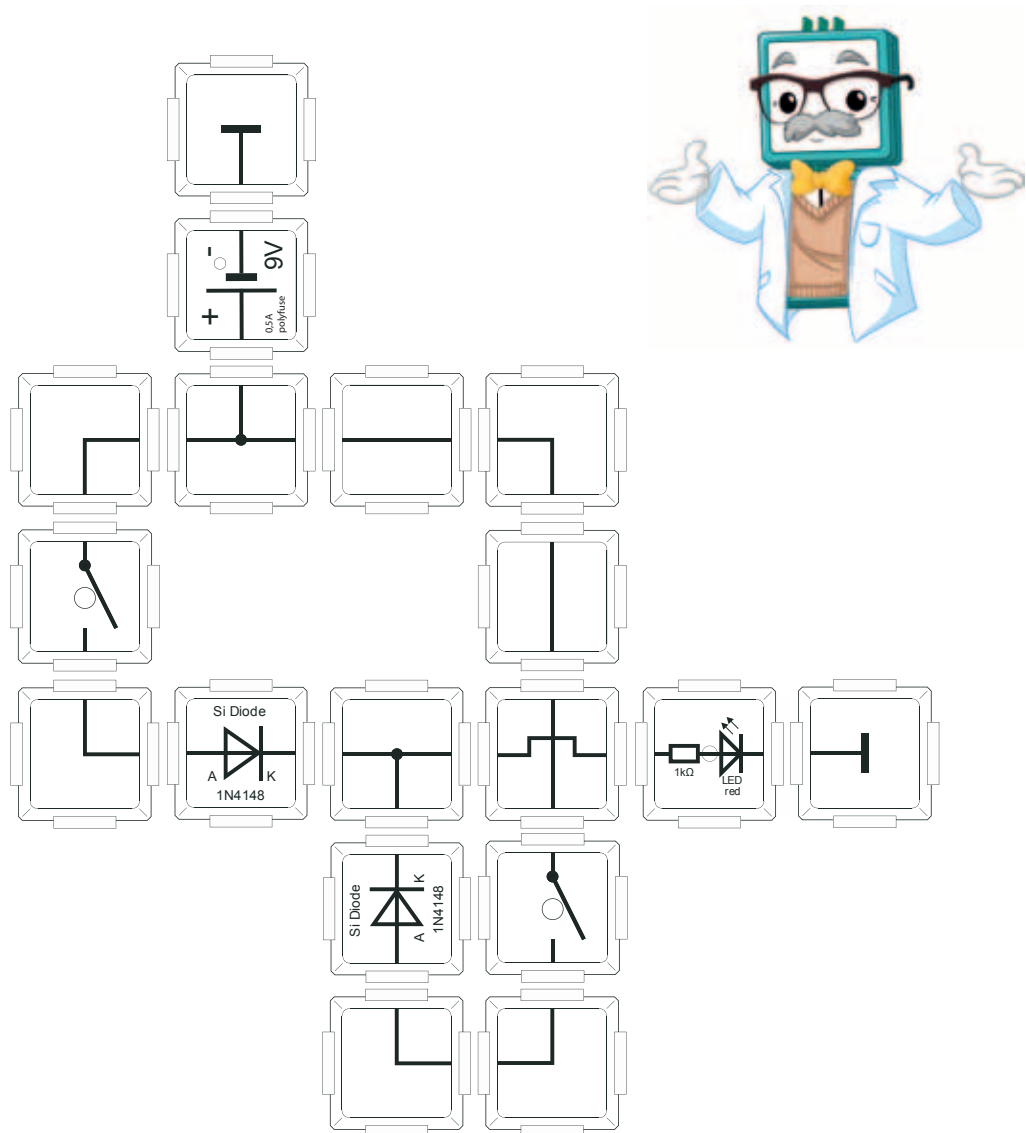

14.3 NAND-circuit with transistors

The NOT AND (NAND) operation is one of the most widely used logic elements. Its built into the so called NAND gates using electronic switches. With either the NOR function or the NAND function, all kind off different logic gates can be implemented. There is no formal logic function that can not be built up using those basic functions. This shows the importance of these functions, especially in computer technology.

Only when both buttons are pressed, the LED will turn OFF.

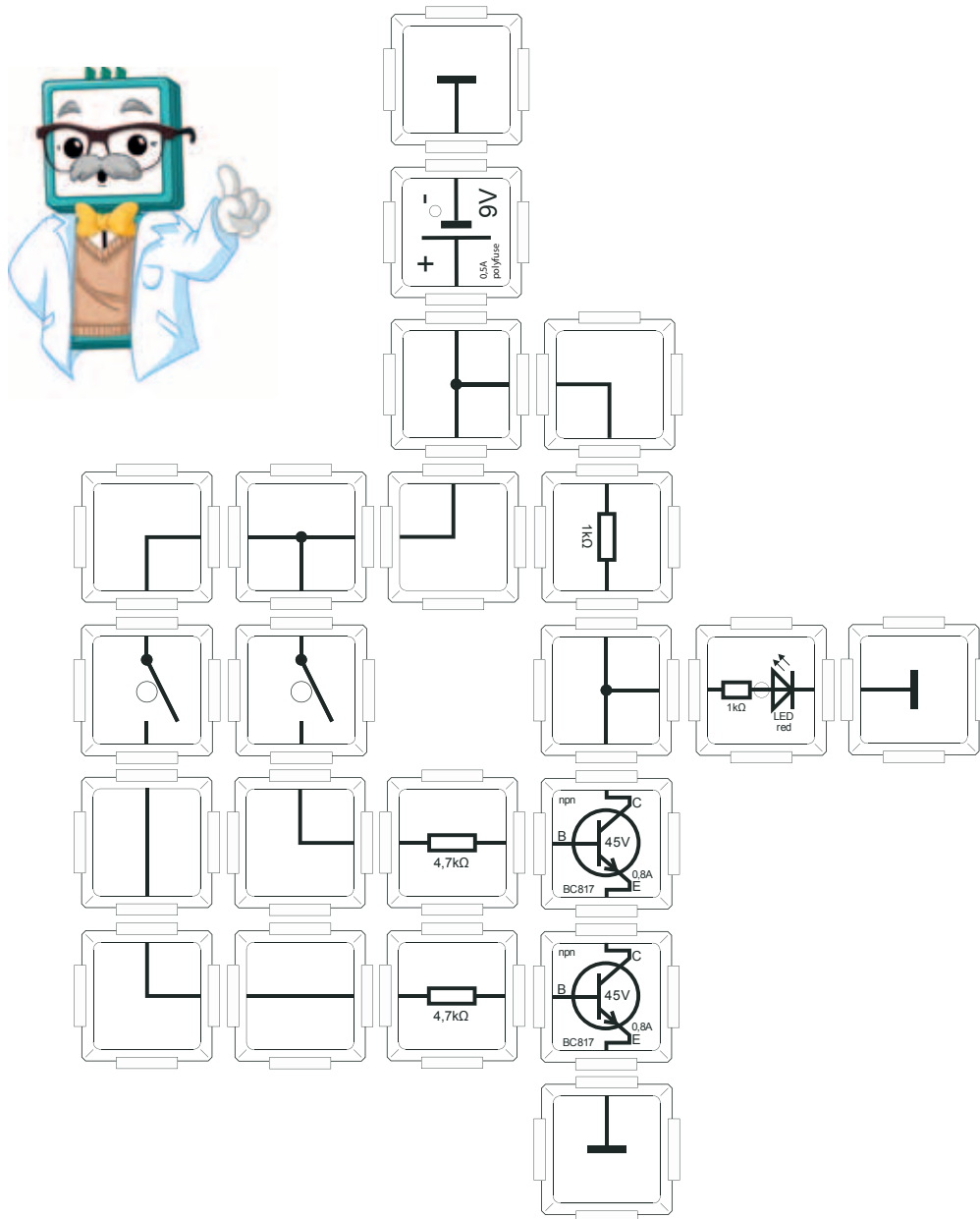

Button 1	Button 2	Red LED
OFF (0)	OFF (0)	On (1)
On (1)	OFF (0)	On (1)
OFF (0)	On (1)	On (1)
On (1)	On (1)	OFF (0)

The red LED does not light up only when switch 1 and switch 2 are pressed at the same time, which is shown in the last row of the table.

14.4 NOR-circuit

The NOR (Not Or) function is in addition to the NAND operation the second elementary logic function. Its built into the so called NOR gates using electronic switches. This circuit shows the simplicity of the basic principles in electronic circuits. While the NAND function has two series connected transistors in parallel with the output of the LED, the NOR function has two transistor connected in parallel to the output of the LED. The NOR operation is one of the fundamental functions in electronics.

The red LED turns OFF, when one or the other or both buttons are pressed at the same time.

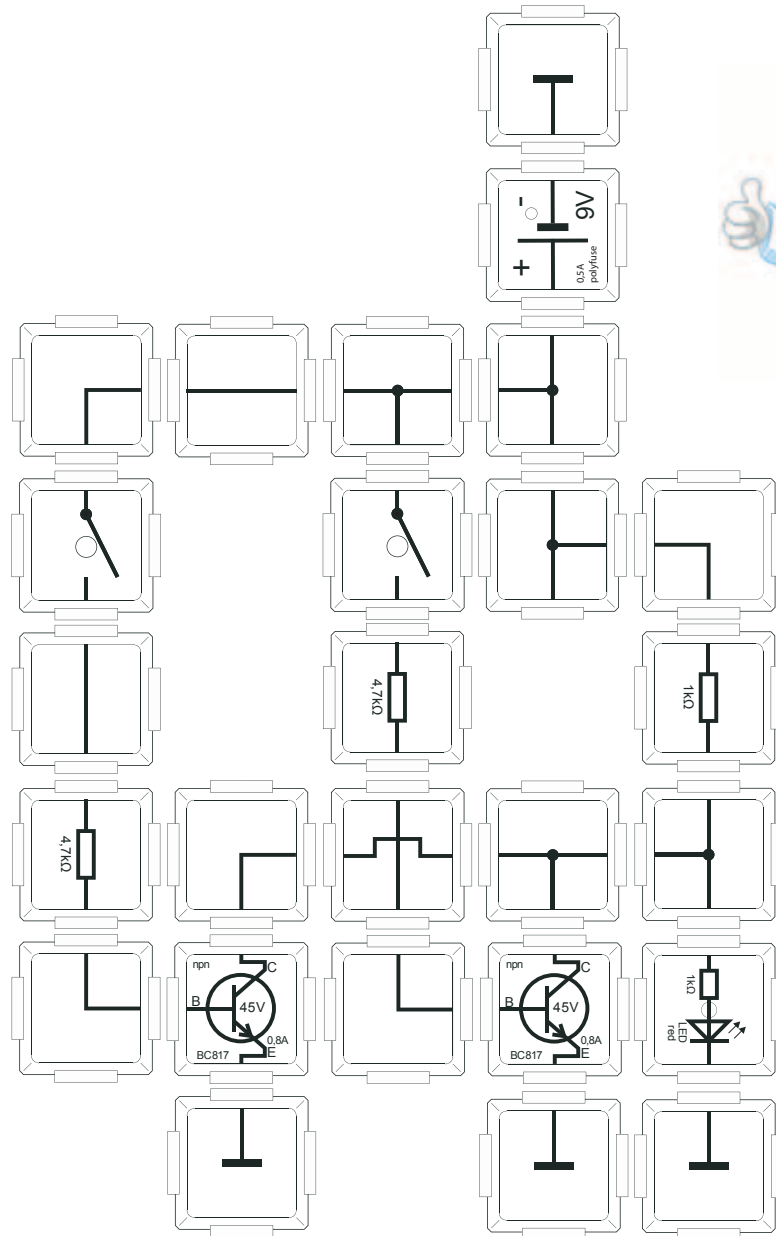

Switch 1	Switch 2	red LED
OFF (0)	OFF (0)	ON (1)
On (1)	OFF (0)	OFF (0)
OFF (0)	On (1)	OFF (0)
On (1)	On (1)	OFF (0)

The red LED lights up only when switch 1 and switch 2 are not pressed, which is shown in the first line of the table.

14.5 AND-circuit

In the last experiment, we have found out the negating effect of the NAND circuit. Logically a negated NAND should again give a AND function. This is done in our circuit by adding another transistor in series to the output of the NAND gate. When both push buttons (switch 1 AND switch 2) are closed, the red LED turns ON.

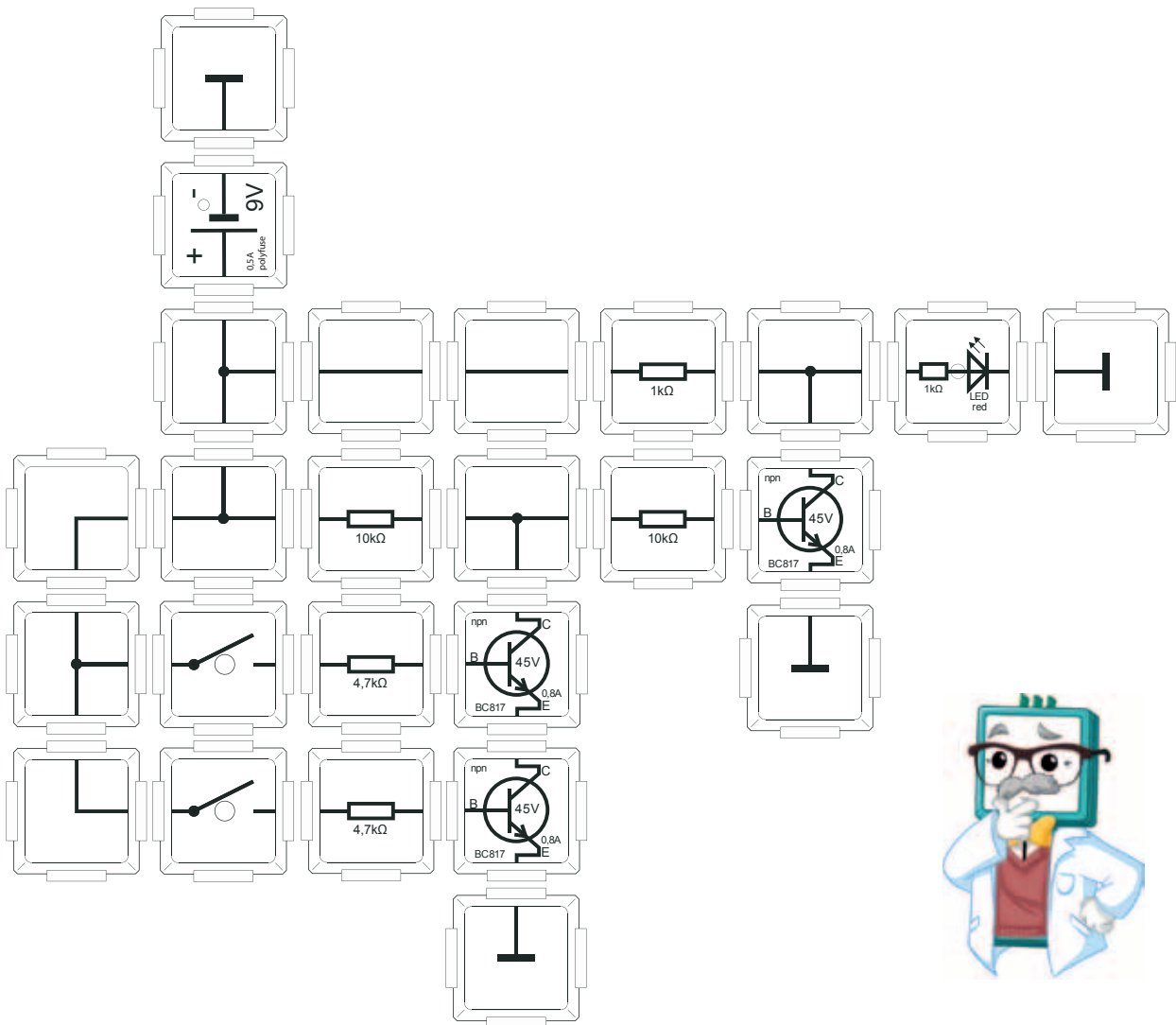

Switch 1	Switch 2	red LED
OFF (0)	OFF (0)	OFF (0)
On (1)	OFF (0)	OFF (0)
OFF (0)	On (1)	OFF (0)
On (1)	On (1)	ON (1)

The red LED lights up only when the switch 1 and switch 2 are pressed at the same time.

14.6 OR-circuit

An OR circuit can be implemented by a double negation similar to the AND circuit implementation in the previous example. So we used the NOR gate and just connect a NOT gate in series to the output. Now the OR function is implemented, the LED is turned on when push button 1 oder push button 2 or both are pressed.

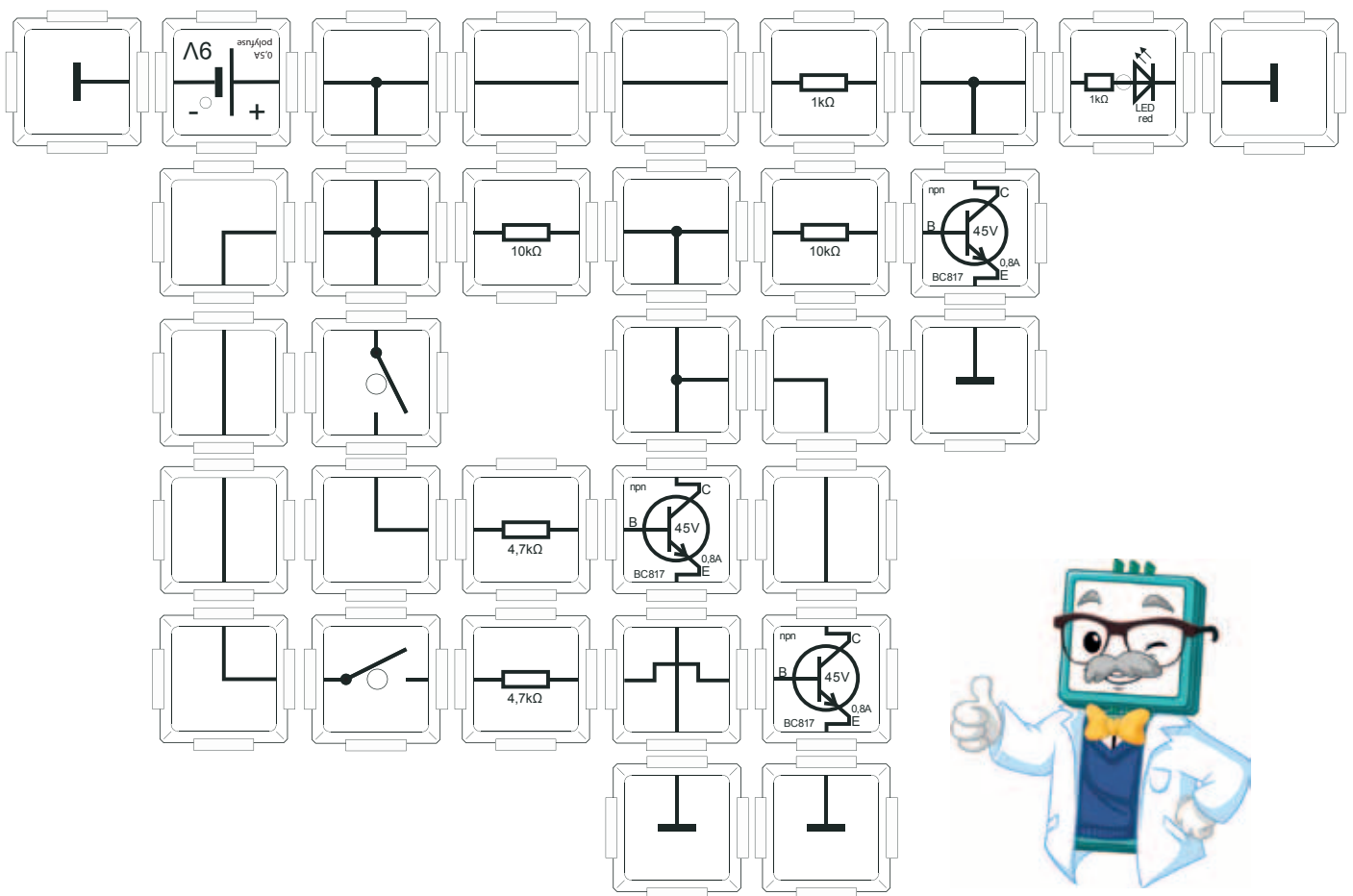

Switch 1	Switch 2	Red LED
OFF (0)	OFF (0)	OFF (0)
On (1)	OFF (0)	ON (1)
OFF (0)	On (1)	ON (1)
On (1)	On (1)	ON (1)

The red LED turns on when switch 1, switch 2 or both are pressed.

15. Oscillators

15.1 RF oscillator 13.56 MHz ISM Band

The oscillator circuit uses a frequency of license-free ISM band (Industry, Scientific and medical band). The radio spectrum is partitioned into different bands for different users, to prevent interference. Our crystal is with 13.56MHz in the lower part of the radio spectrum, also called short wave. Many commercially available transponders (eg RFID) transmit on this wavelength. The crystal used in our circuit is characterized by a high stability. The frequency can be increased by a capacitor. In our example we use the 33pF capacitor. In order not to interfere the conventional radio frequencies, please do NOT connect the antenna, because this will generate secondary frequencies that are much higher than those generated by the crystal.

The capacitor at the collector of the circuit acts in an AC circuit like a resistor. All DC components are blocked, only the AC current will reach the two antiparallel LEDs. The red LED shows the negative and the yellow LED the positive half-wave. Due to the high switching frequency the effect is visible by a very small glow of the two LEDs. The flickering of the LEDs with around 13.56MHz cannot be seen by the human eye, which has a limit of around 100 Hz.

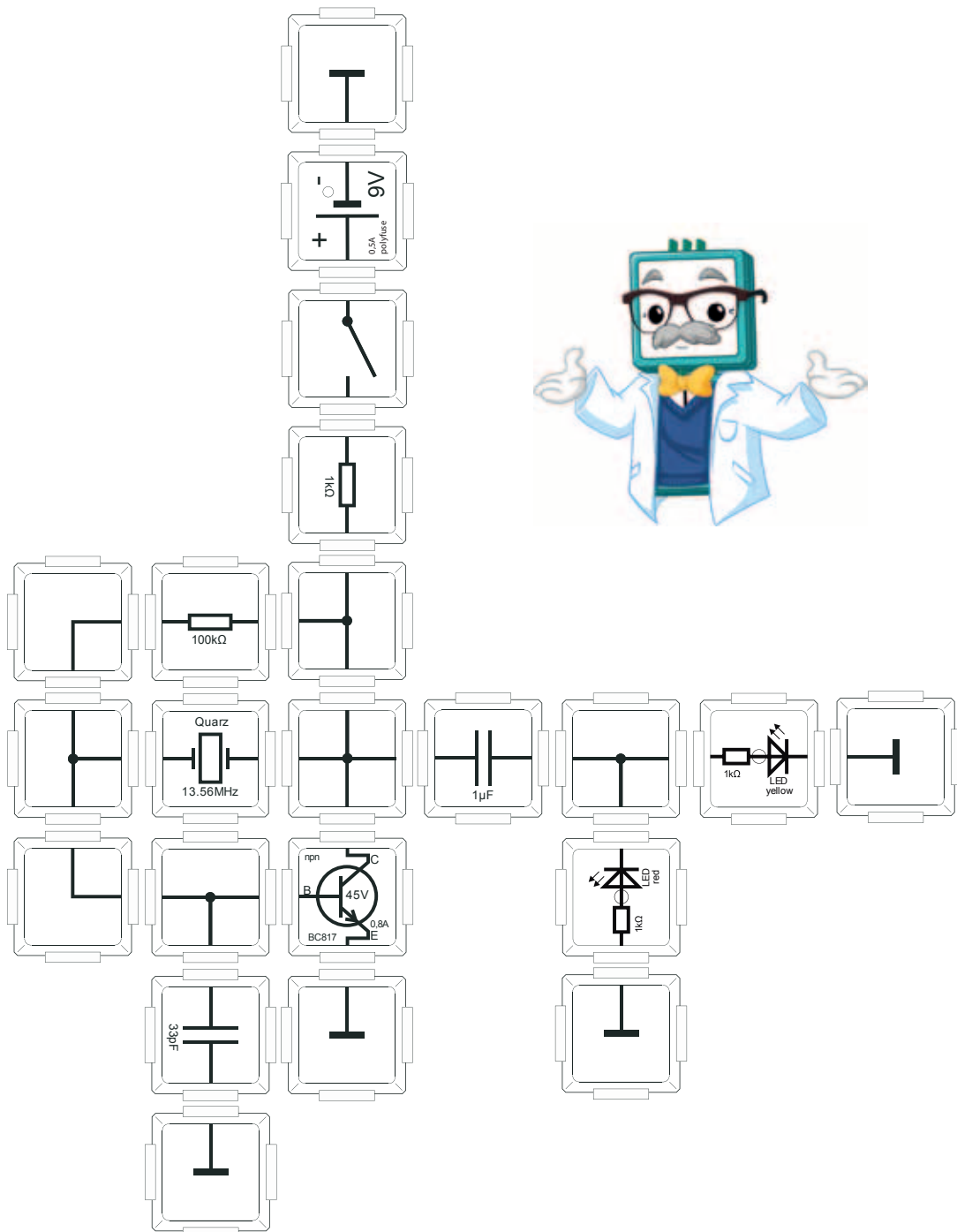

15.2 Crystal oscillator with tuning (trim)

This circuit generates a unmodulated carrier, but when using a SSB receiver you can make sound audible by detuning. The pitch can also be changed by the trimmer (i.e. changing the carrier frequency). The single-sideband modulation (SSB) is often used as modulation standard since a long time, to save bandwidth. Still used for ham radio operation. Sometimes available on world receivers and radios.

It has the advantage that the total transmit power is used for the broadcast of the information. In example 15.1 the frequency is constant, therefore the world receiver can hear a constant whistling. With the variable capacitor, we trim the resonance frequency of the quartz crystal slightly, so that the pitch is varied. A conventional radio processes our signal as a changing noise since the peak value of the oscillation does not undergo any change.

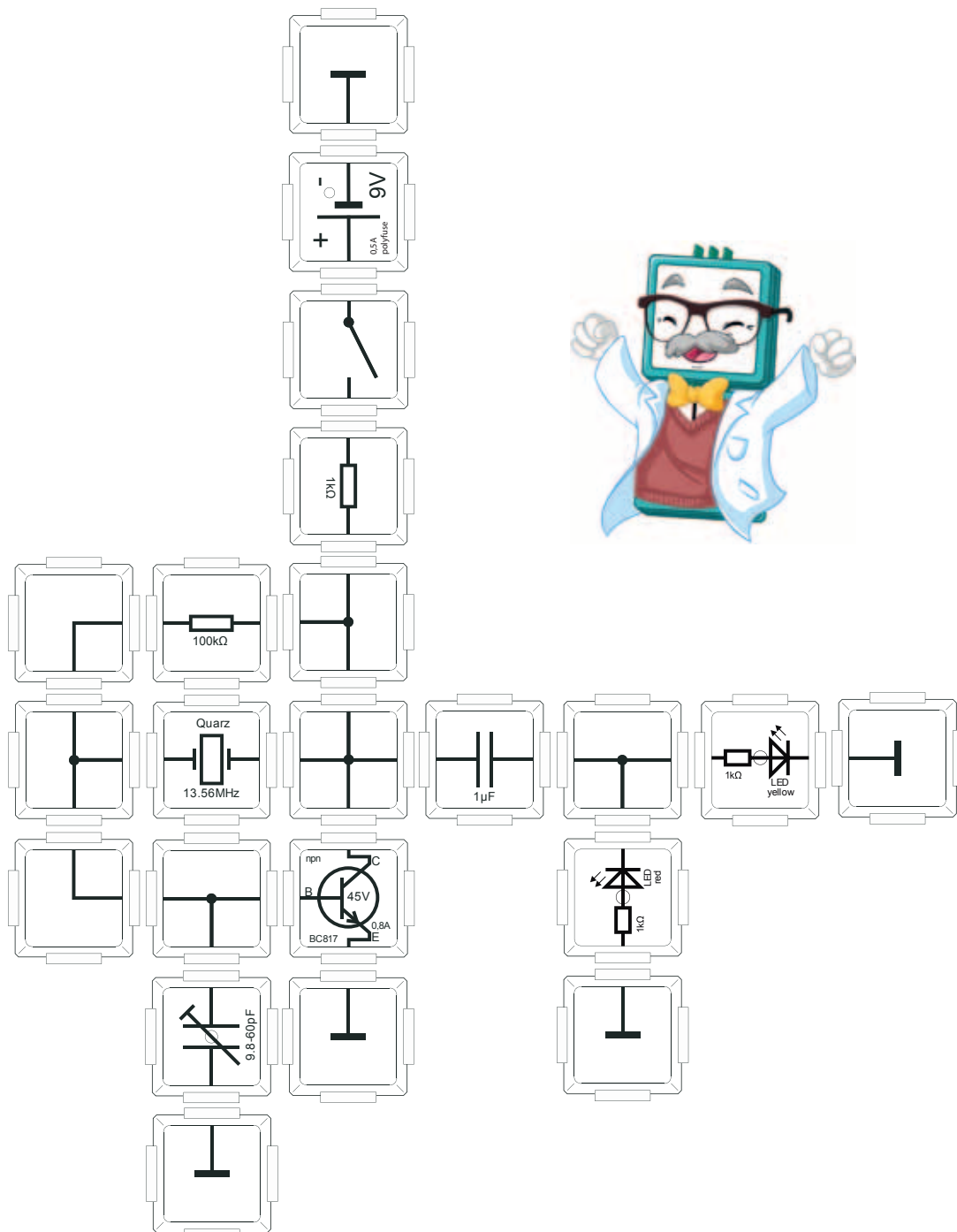

15.3 Crystal oscillator with capacitance diode for tuning

The capacitance diode is a special electronic device. Connected in reverse direction, it changes the capacity depending on the applied voltage. The physical basic principle for this is simple.

The barrier layer in the diode acts like a dielectric and its thickness changes depending on the negative voltage. The higher the amount of voltage, the smaller the capacity. The tuning of an oscillator with the diode can thus be carried out very accurately via a potentiometer. Again, the world receiver with SSB modulation can show this effect. The diode used (BB131) has a capacity range from 1pF to 14pF.

These capacities are very small for capacitors, so that they are only suitable for special applications. Since the frequency is very high, and the capacity very low, this can even have influence.

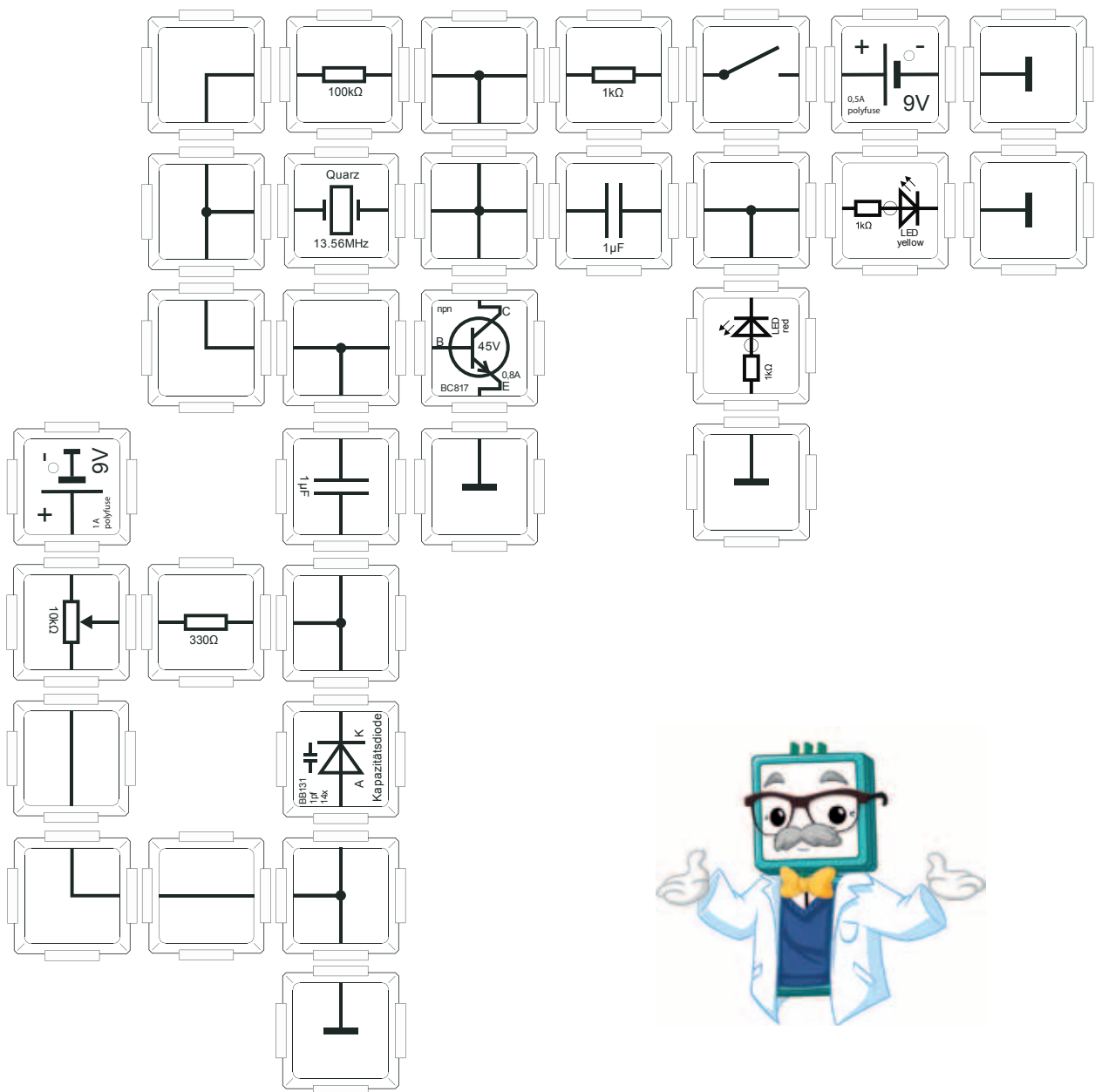

15.4 Oscillator resonant circuit with capacitor and coil

Another way to generate an electrical oscillation is the connection of capacitor and coil. Both have exactly opposite properties. At the capacitor the current leads the voltage change, while charge can be said to the coil the voltage leads the current. Since both have a frequency dependent resistance (reactance), it is directed exactly opposite. The charge applied oscillates between these components. The resulting resonant frequency is only dependant on the value of the capacitor and the inductance of the coil. Our antiparallel diodes can indicate the function. When both are LEDs light up, an AC voltage is applied. With an oscilloscope or a frequency-meter this can be verified between ground and the anode of the red LED.



The Thompson oscillation formula calculates the resonance frequency₀(f):

$$f_0 = \frac{1}{2 * \pi * \sqrt{L * C}}$$

For the center position of the variable capacitor (300pF) this results in:

$$f_0 = \frac{1}{2 * \pi * \sqrt{10\mu H * 300pF}}$$

$$f_0 = \text{around } 3\text{MHz}$$

With other coils:

$$L_1 = 10\mu H, L_2 = 22\mu H, L_3 = 100\mu H,$$

$$C = 10 - 300pF$$

$$f_1 =$$

$$f_2 =$$

$$f_3 =$$

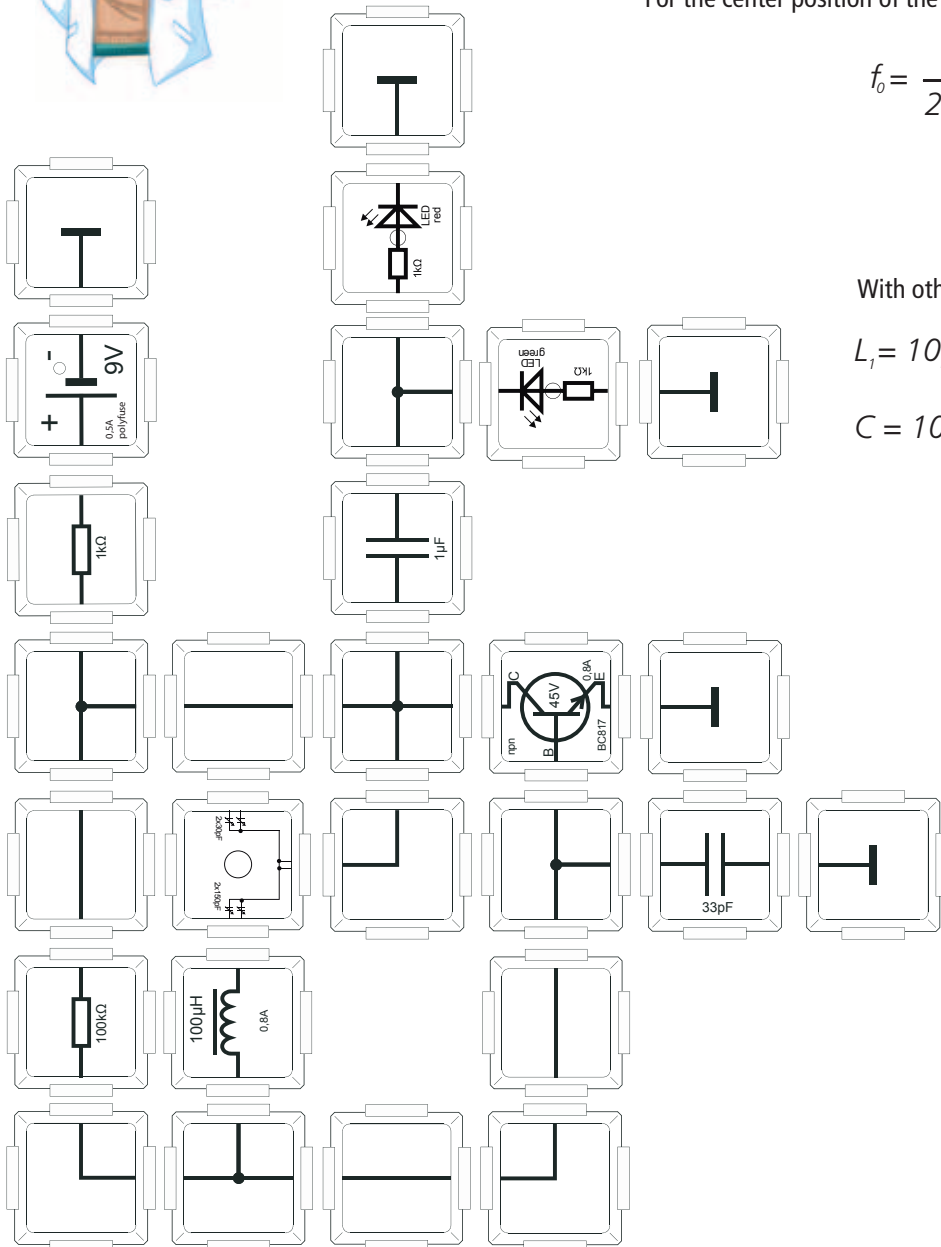

16. The operational amplifier

16.1 Function of the OPAMP

The OPAMP is a complex integrated circuit. It can amplify the voltage difference across its two inputs, one is marked with plus, while the other is marked with minus. The gain can reach up to several hundred thousand. Our OPAMP (LM662) is built with MOSFETs, so the current flows at its inputs in the femto range (10⁻¹⁵) is very small. MOSFETs can already be destroyed by small electrostatic loads. So you have to be careful when using this brick. The voltage divider from the 10kΩ-fixed resistors halves the supply voltage. The polarity of the output voltage changes when the threshold is below 4.5 V, as a result, the red LED turns off. The sign change of the output voltage takes place when turning the potentiometer clockwise and the center position is exceeded.

In the second circuit the special brick at the input of the OPAMP is rotated by 180 degree, so that the polarity is reversed. To get the same results, the potentiometer must be adjusted in the opposite direction.

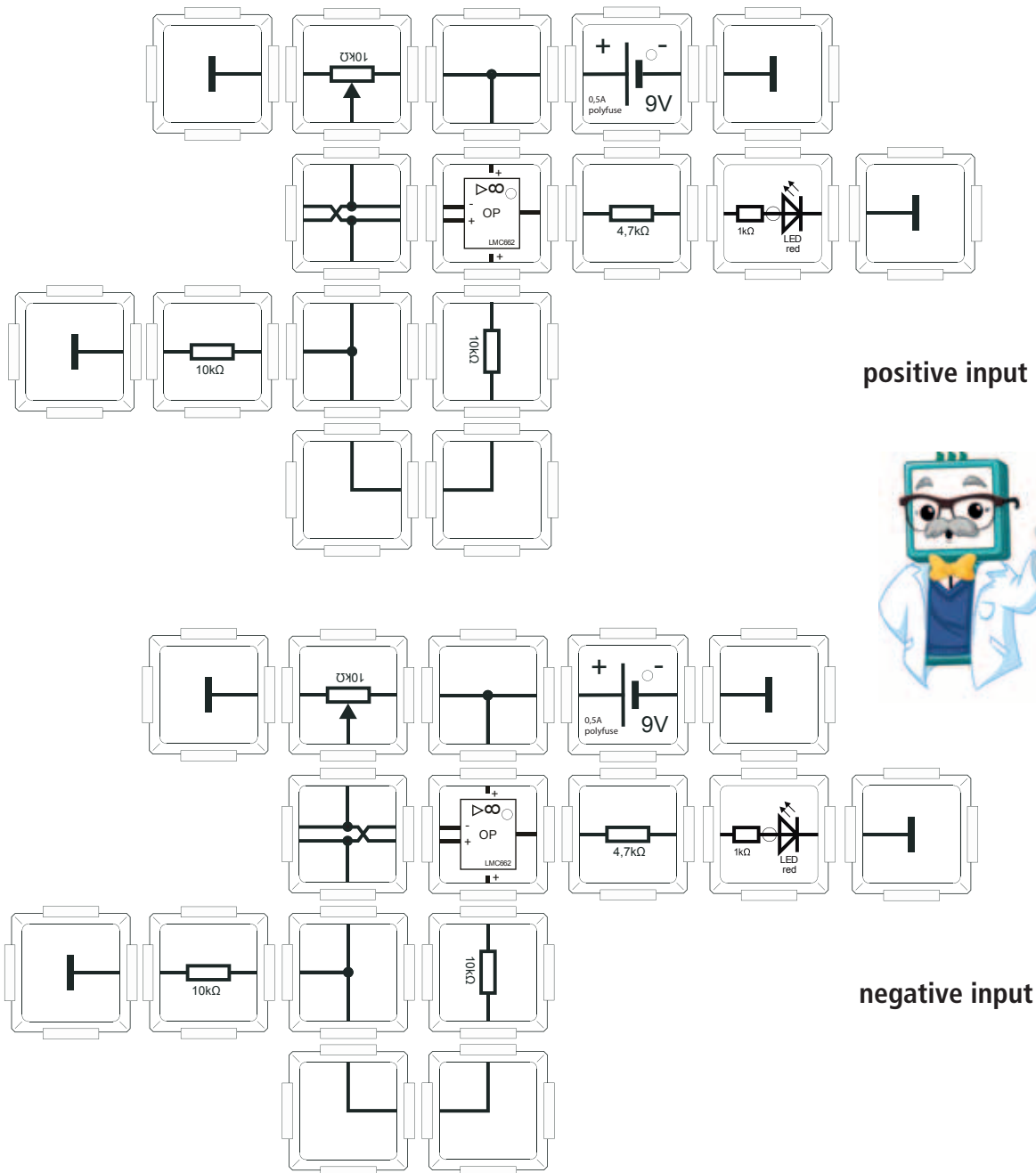

16.2 OPAMP as a voltage follower

Operational amplifiers have several basic circuits. We already know one of them: the differential amplifier. Another is the wiring as a voltage follower. Here the minus input of the OPAMP is connected to its output and the plus input is connected to the potentiometer, followed by a ground-brick. The voltage difference between the plus and minus input of the OPAMP should be zero. The OPAMP tries to compensate any voltage difference and though the output follows the voltage applied to the positive input.

For: $U_+ = U_-$ and $U_- = U_a$, with this it results also: $U_a = U_+$.

The intensity of the red LED can now be controlled by the potentiometer. The advantage of this circuit is that the potentiometer is loaded only very slightly by the high impedance of the input, in contrast to a direct control over the potentiometer. Therefore, other components can be used which might have a much higher resistance than the 10kΩ potentiometer.

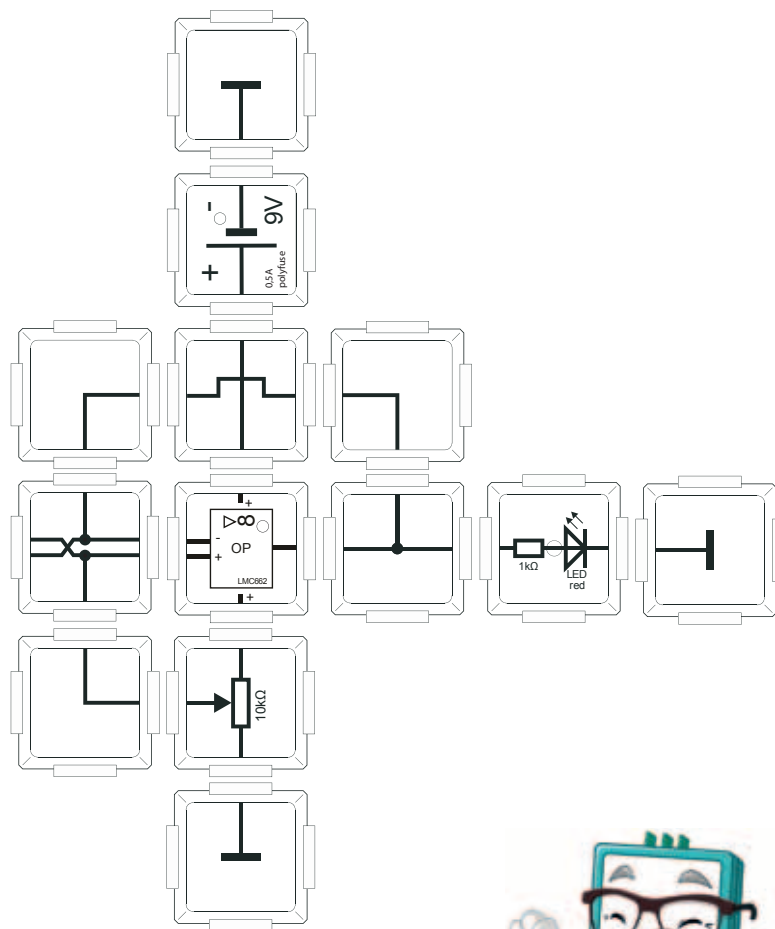

16.3 OPAMP as non-inverting 11:1 amp

The voltage follower is a special form of the amplifier, with a gain factor of 11.1 in the previous example. This gain is defined by the ratio of the resistor from the minus input connected with ground to the sum of both resistors. The sum means the resistor to ground and the resistor from the minus input to the output.

The following applies: $U_+ = U_- = U_a * \frac{R_1}{R_1 + R_2}$ transformed:

$$U_a = (U_-) * \frac{R_1 + R_2}{R_1}, \text{ with specific values:}$$

$$U_a = (U_+) * \frac{10k\Omega + 100k\Omega}{10k\Omega}, U_a = 11 * (U_+), \text{ the gain is } 11.$$

So the output voltage is 11-times higher than the input voltage. Changing the input voltage via the potentiometer quickly changes the output voltage (by a factor of 11) and though the intensity of the LED. The output voltage can not be increased above a maximum value. The limit is reached with 1/11 of the supply voltage at the plus input of the OPAMP. Thereafter, no change in the light intensity of the LED can be observed, because the maximum value is reached.

The polarity of the output voltage is positive (non inverting) as the plus input is used for the signal.

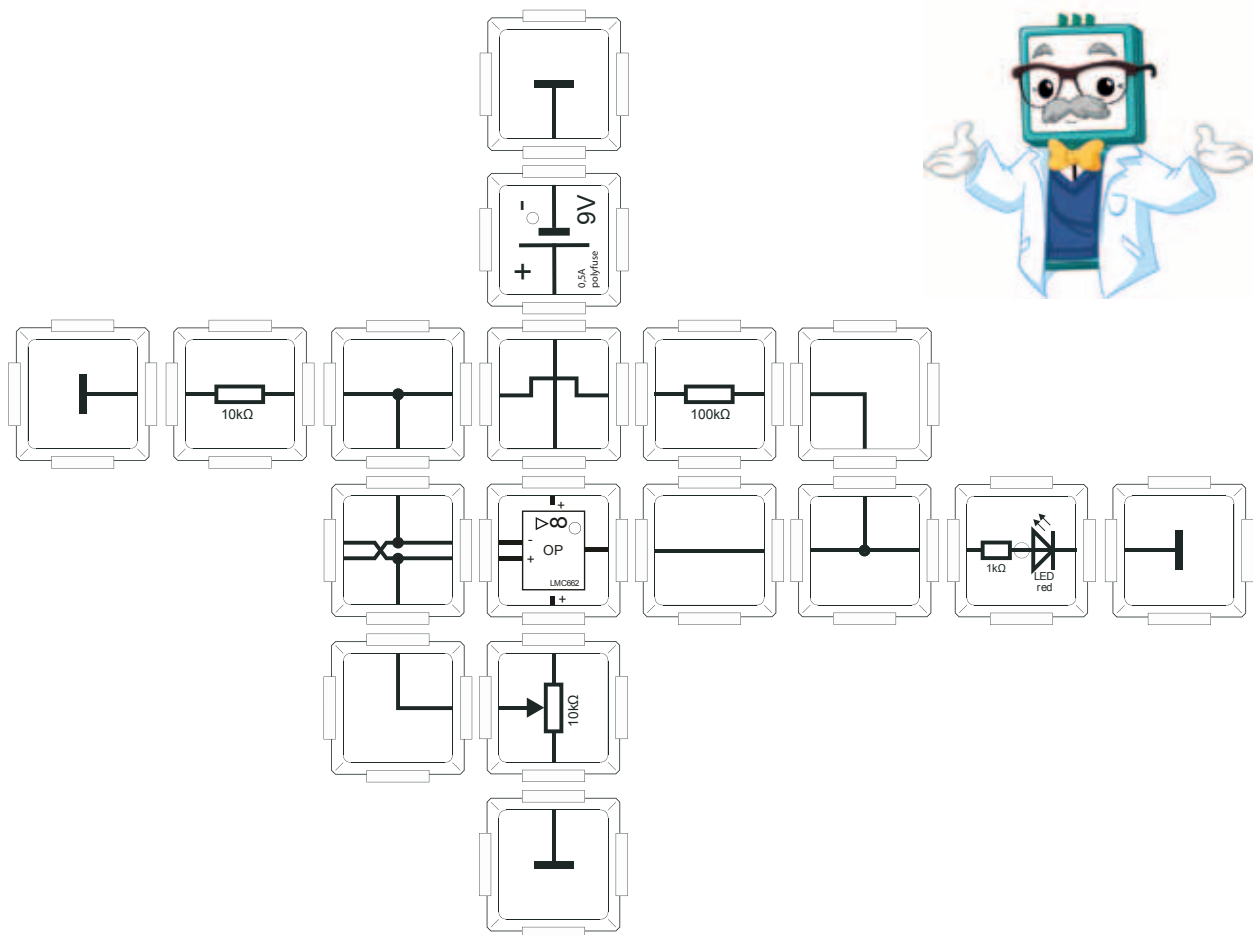

16.4 OPAMP as an inverting 10:1 amp with virtual ground

The following circuit has two learning objectives. The creation of a virtual ground and the change in voltage at the negative input. An easier implementation option is to apply a negative voltage at the inverting input to amplify and result in a positive output voltage. The gain factor is -10. It is given by:

$$(U+) = (U-) \rightarrow U+ = \frac{1}{2}U_{max} = 4.5V, \text{ thus:}$$

$$(U-) = (U_a - U_e) * \frac{R_1}{R_1 + R_2} + U_e = (U+) = \frac{1}{2}U_{max}$$

To obtain the output voltage, the term must be solved for U_a

$$U_a = ((U-) - U_e) * \left(\frac{R_1 + R_2}{R_1}\right) + U_e, U_a = (U-) * \frac{R_1 + R_2}{R_1} - U_e * \frac{R_2}{R_1}$$

if $(U+) = 0V$ than $U_a = -U_e * \frac{100k\Omega}{10k\Omega}$ This corresponds to a gain of -10 for 100kΩ and 10kΩ

The red LED lights up when the wiper of the potentiometer is moved clockwise. The output voltage changes its sign in relation to 4.5V and there is a virtual ground at 4.5V at the minus input.

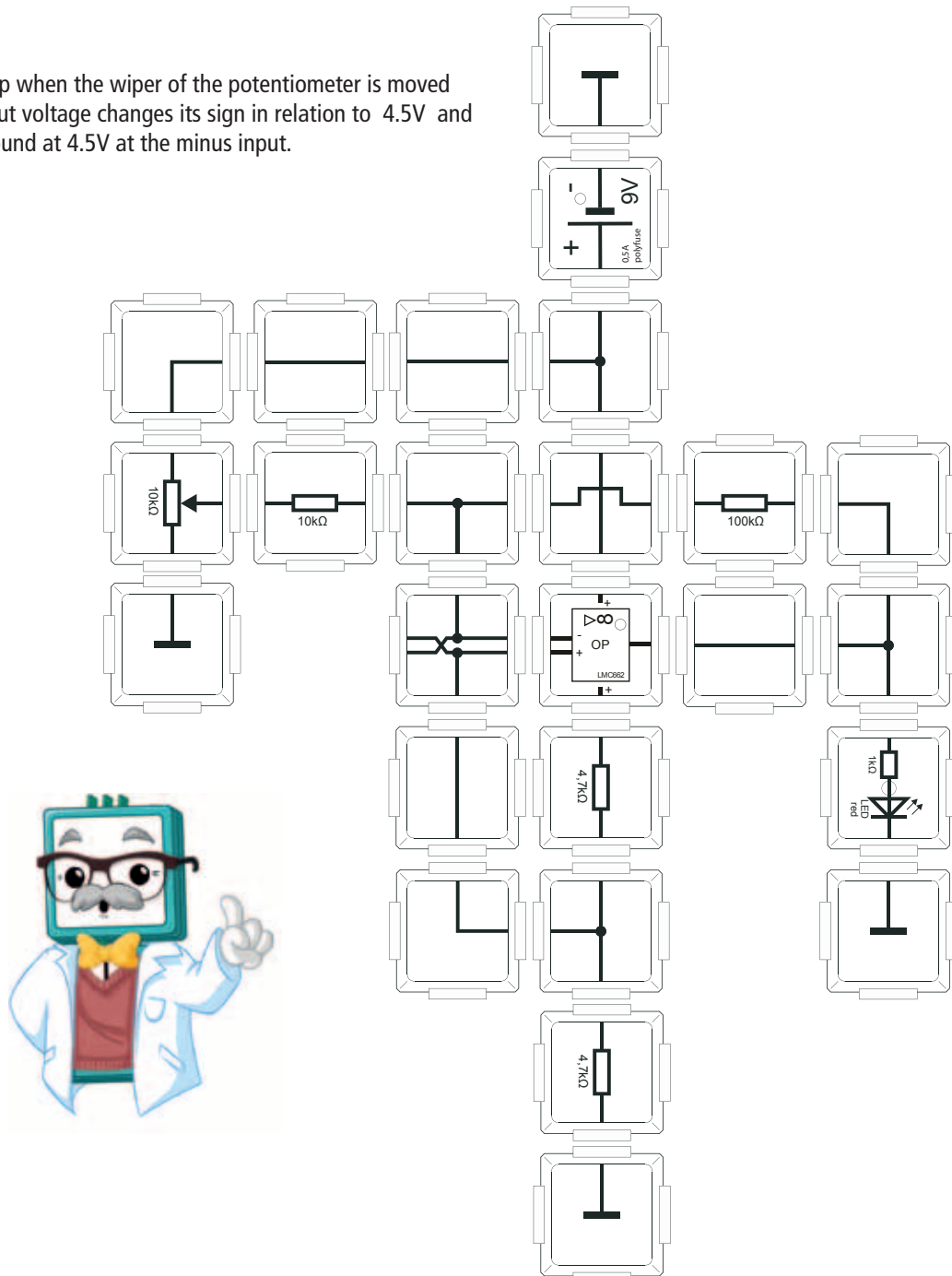

16.5 OPAMP as an integrator

Even complex mathematical functions, such as integrating, can be created with the OPAMP. The integration determines the area under a function, whose function values are added. In this experiment the sum is implemented by the capacitor, total charge depends on the time a current flows into it. It looks like the LED is responding very slow, the capacitor integrates the voltage difference at the input.

By moving the wiper to the left, the output voltage increases and the LED lights up. When moving to the right, the output voltage becomes negative and the LED goes out.

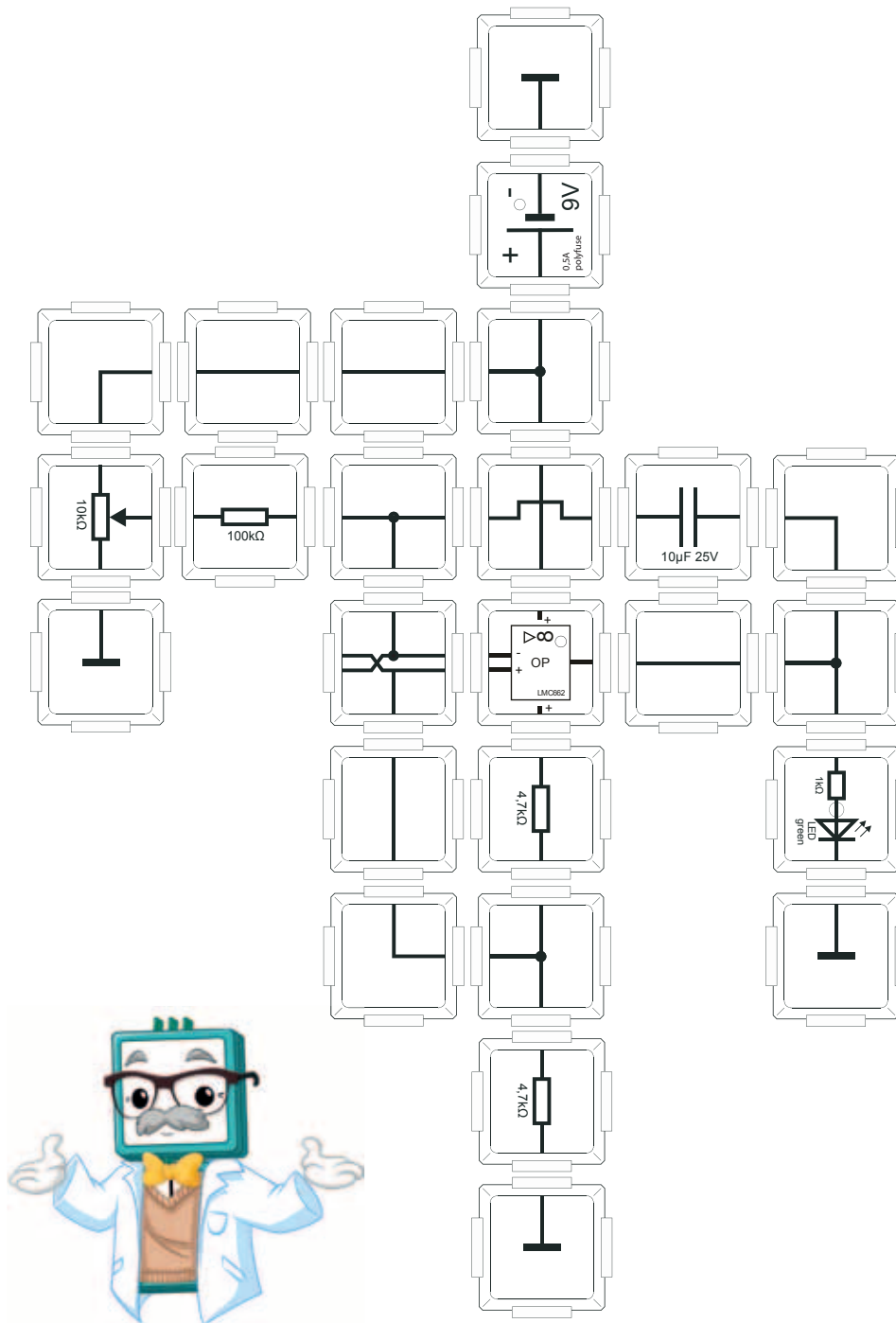

16.6 OPAMP as a differentiator

A differentiator amplifies the voltage change according to the time at its input. The reference is again half of the supply voltage. Don't mix it up with the differential amplifier, an other story. The mathematical operation is the differentiation. Here the limit of a curve is determined at one point. Both arithmetic operations, the differential and integral calculus, base on the limits and are therefore also called calculus. This was discovered by Newton and Leibnitz simultaneously and independent of each other in the 17th century.

Only if there is a voltage change at the input of the capacitor, a change in its output voltage occurs, so that the OPAMP defines a output voltage provided by the resistors ratio. The faster the change the less is the resistor of the capacitor and there for a differential is formed according the the signal at the input, also determined by the 100k resistor and the ratio of the both.

You need to move the potentiometer wiper constantly from left to right to see the LED flashing. If the wiper is not moved, no voltage changes takes place and the green LED turns off.

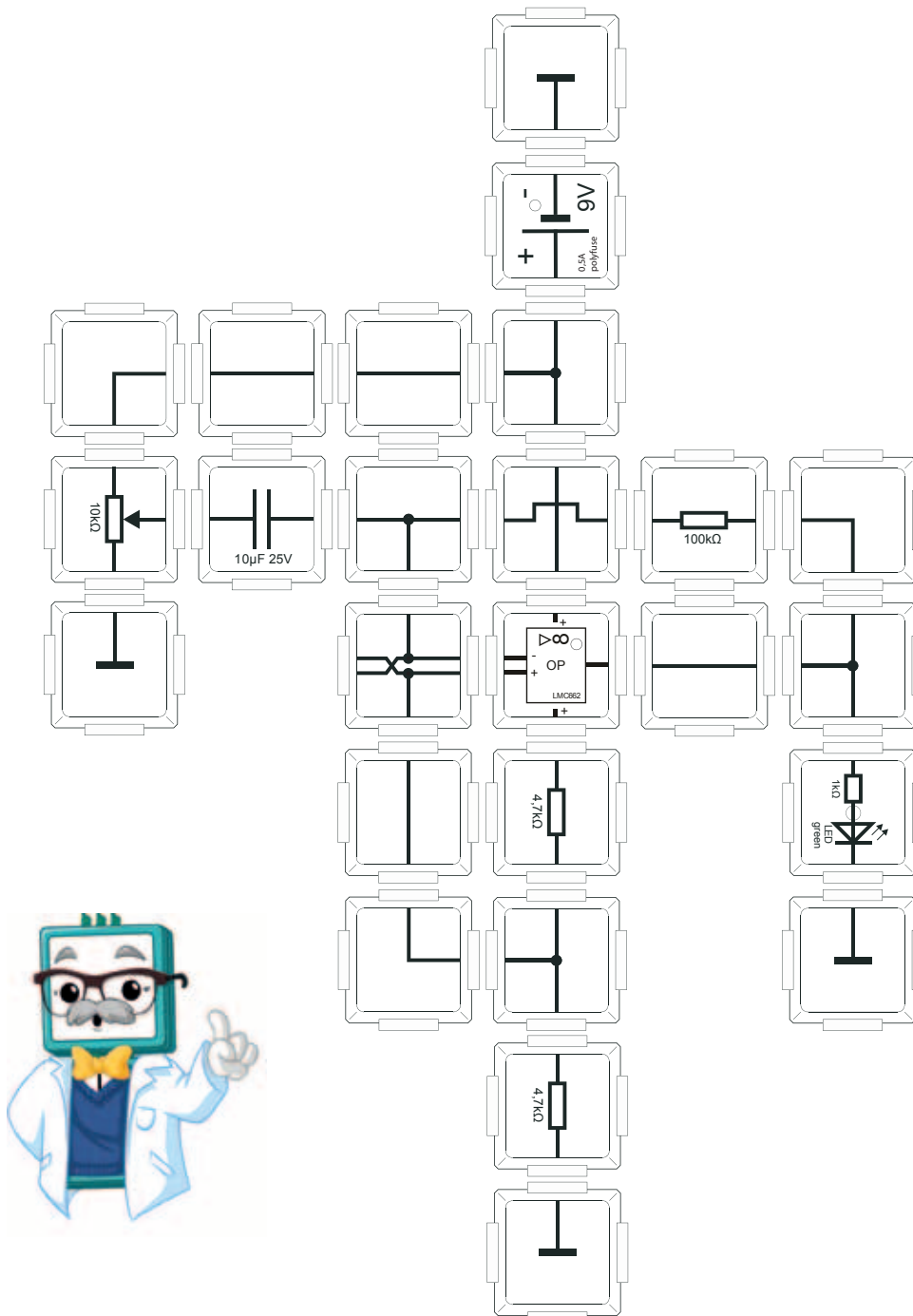

16.7 OPAMP as oscillator with coils and capacitors

The operational amplifier is also used to generate oscillations. The „clock“ is a classic series circuit of capacitor and coil that is connected to the plus input and implements the feedback of the output to the input.

The amplitude of the output voltage is determined by the potentiometer at the negative input and the amplification factor (5.7) of the resistance ratio of $4.7\text{k}\Omega$ to $1\text{k}\Omega$. The green LED lights up only, when the wiper of potentiometer is in the right range clockwise from the start.

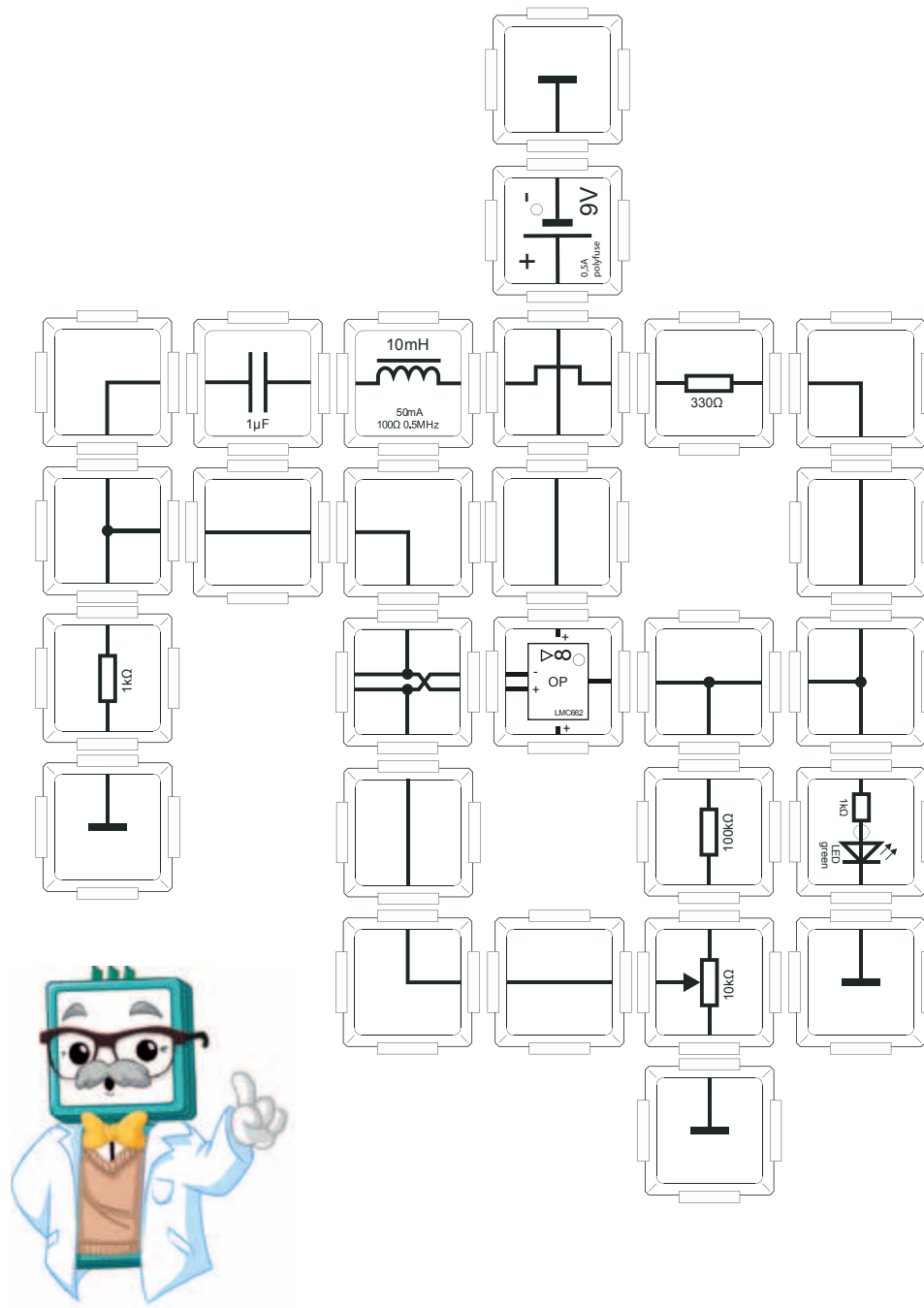

16.8 Wien-Robinson-Oscillator

The classical Wien-Robinson bridge circuit uses only resistors and capacitors, but no coils to generate an oscillation. If the gain is exactly three, then a sine signal is generated at the output. The setting of this operating point is very sensitive.

Note: Please pay attention to the polarity of this electrolytic capacitor. Anode (+) must not be connected to the ground-brick!

In the following circuit, we have a better alternative to generate a sine wave. At a gain factor higher than three, the oscillation is increasing and it produces a square wave voltage, because the output voltage rises very quickly to its maximum value. If the gain is less than three, the oscillation is damped, and the green LED turns off. With the help of the voltage divider of the two 10kΩ resistors a virtual ground with half of the supply voltage is generated. Thus, makes it easier to generate a sine signal. The potentiometer sets the operating point. If the operation point is exceeded and a square wave produced, it also influences the generated frequency. The 100μF capacitor is used for smoothing the output voltage.

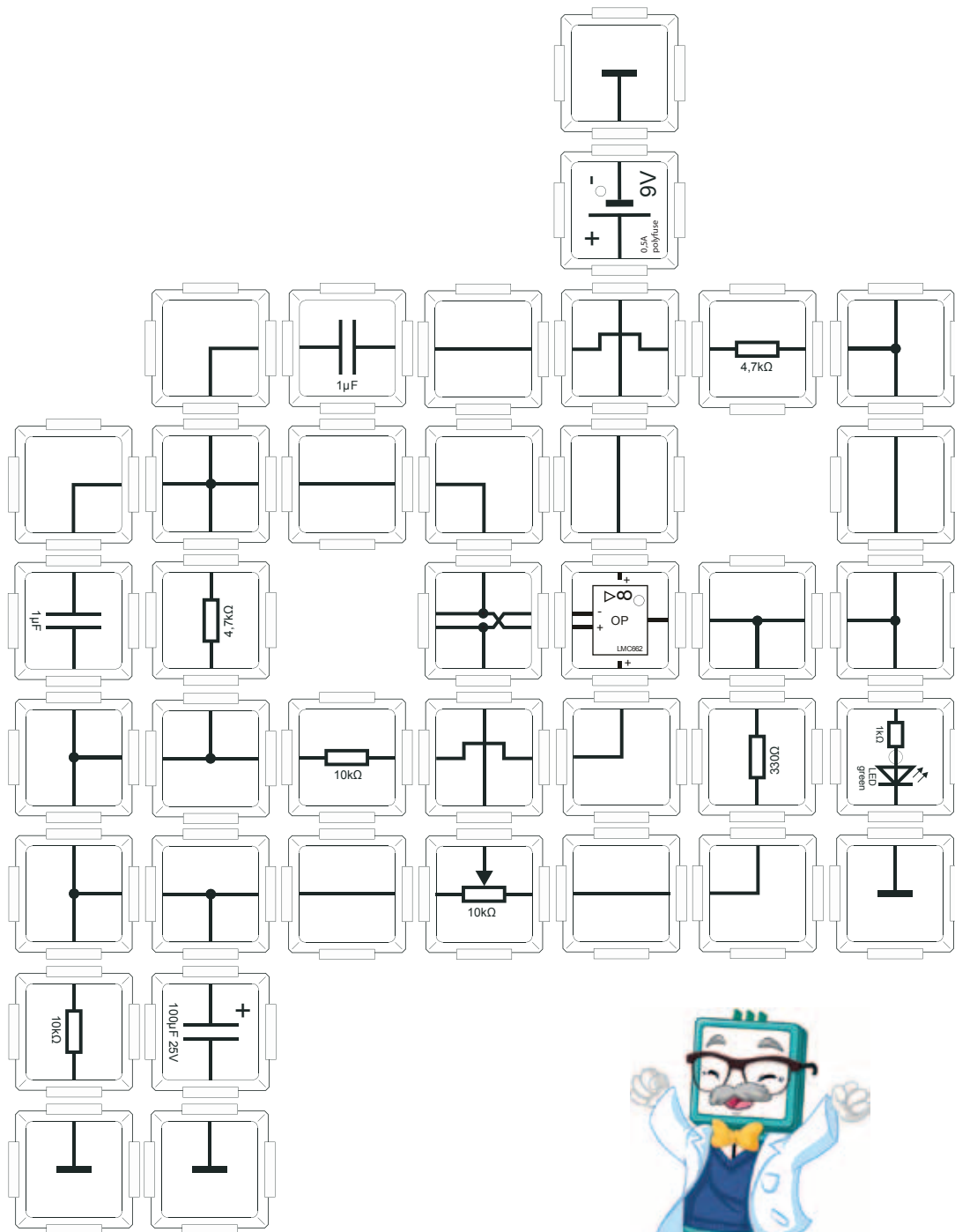

16.9 Wien-Robinson-Oscillator with stabilization

The improved version of the Wien-Robinson oscillator, as seen as in experiment 16.8, here two antiparallel diodes are used to avoid a drifting and thus instable operation. The amplitude can no longer exceed the maximum value of the supply voltage. The setting of the operating point is easy in this experiment, because it needs to be reached or slightly exceeded and is then stabilized through the diodes. Please pay attention to the changes in relation to the last experiment. The capacitor-resistor-ratio is changed by using the 100nF capacitors and 100kΩ resistors, without affecting the frequency. This allows the use of all bricks in the Advanced set. When increasing the value of the capacitor by the factor 10, the period-time is so high, that the green LED flashes. Now the sine signal is very easy to recognize.

For „slow“ sine wave please use 2 x 1 μF capacitors!

$$f = \frac{1}{2 * \pi * R * C} = \frac{1}{2 * \pi * 100k\Omega * 100nF} = 16Hz$$

for 1 μF the period is 0.6s

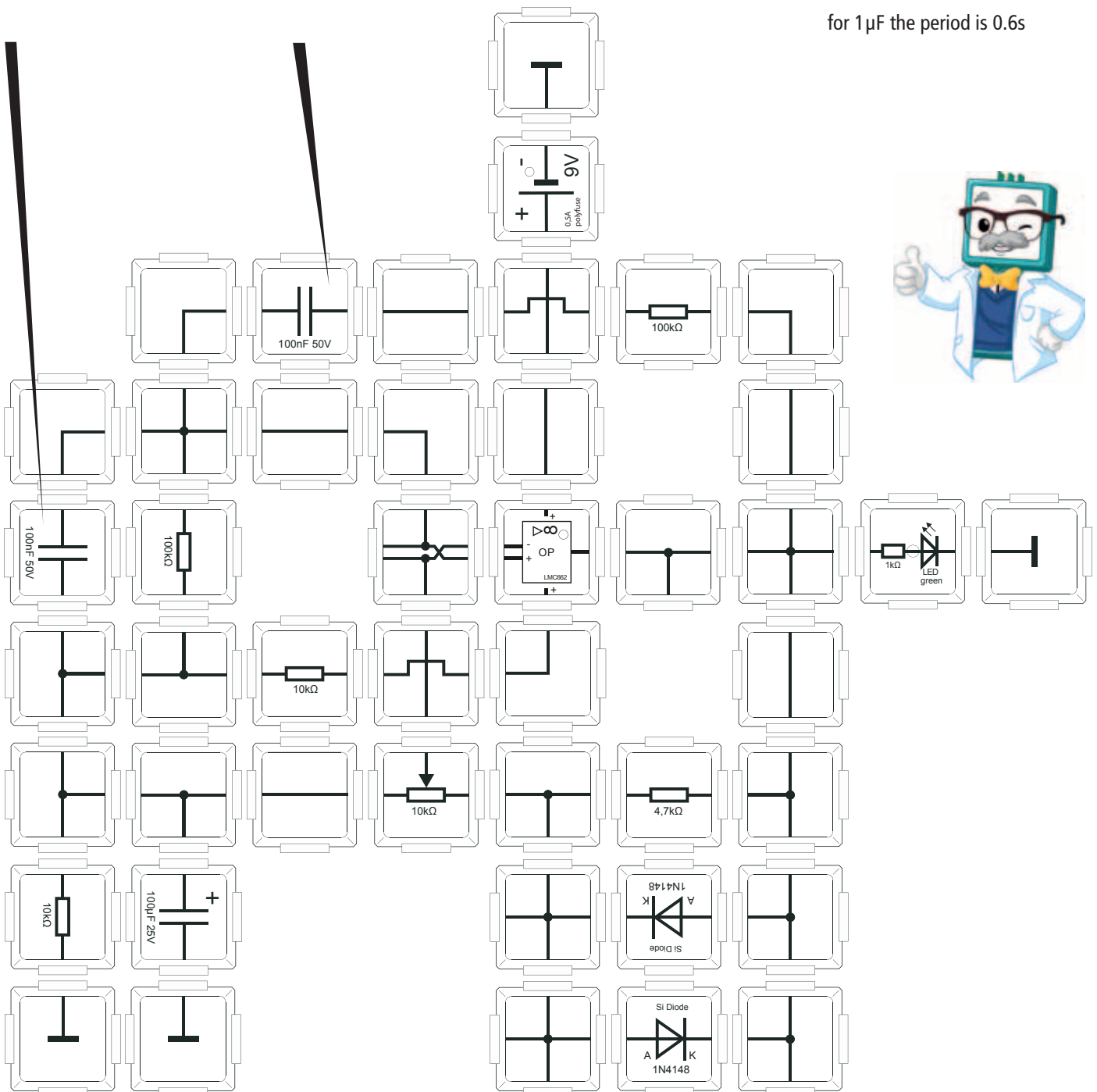

17. Audio amplifier with LM386

17.1 Mixrophone and amplifier

With the OPAMP and the timer 555 brick we already learned about two integrated circuits (IC). Another IC in our Advanced set is the LM386 audio amplifier. It is similar to the basic circuit of our OPAMP, but instead it is suitable especially for the amplification to generate acoustic signals. Internally the gain is set to 200 and the output is coupled via capacitors to allow connecting a 8Ω speaker.

Note: Please note the polarity of the microphone! The 1μF capacitor filters out DC components and the amplitude (volume) is controlled by the potentiometer.

It's important to use two separate voltage sources to avoid feedback. Feedback occurs when the output signal is fed back and the circuit starts oscillating by itself. Unlike normal OPAMPs, the LM386 can be connected in a much simpler way, as the usual gain resistor defining network is done already internally. Another way to counteract the feedback is to set a parallel connected 100μF capacitor between ground and 9V potential. But to make the experimental set up easier, it makes sense to use two voltage sources. Thus even a minimal feedback, still possible though the use of a smoothing capacitor are avoided. The principle of operation is quite simple. The microphone transforms acoustic signals into electric waveforms, they are amplified by the LM386 and sent to the speaker and jack.

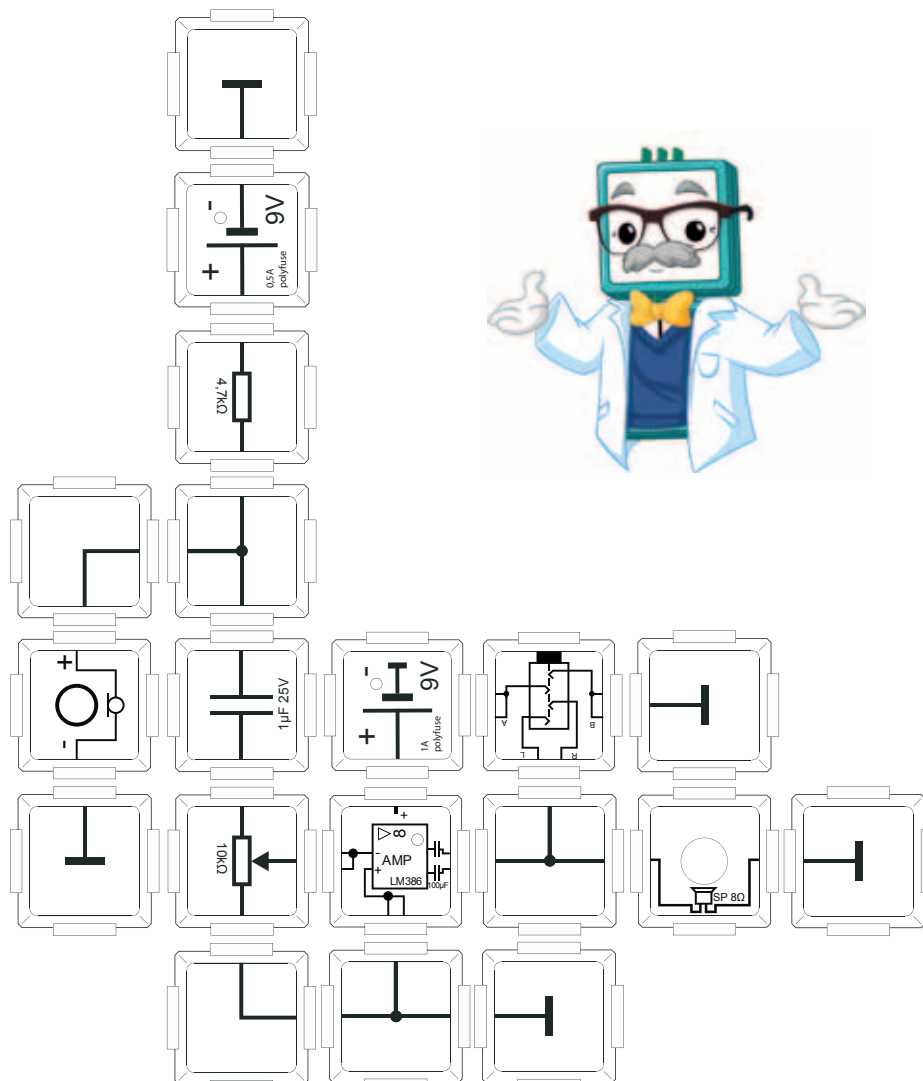

17.2 Noise generator

Diodes and other semiconductor devices consist of so called semi-metals. They combine both properties of insulators and conductors. In semiconductors charges fluctuate constantly. This fluctuation is dependent on many parameters, in particular on temperature and can be interpreted as noise as a sum of many overlapping random sine waves with different frequencies.

This is similar to the noise or so called statics of a radio receiver, which is not tuned on a modulated signal, or similar to the sound of the sea.

In the following circuit, the noise of a diode is pre-amplified by a transistor and then output via the LM386 to the speaker.

Close the switch at the power supply of the LM386 for the circuit to work. With the potentiometer you can adjust the sound volume.

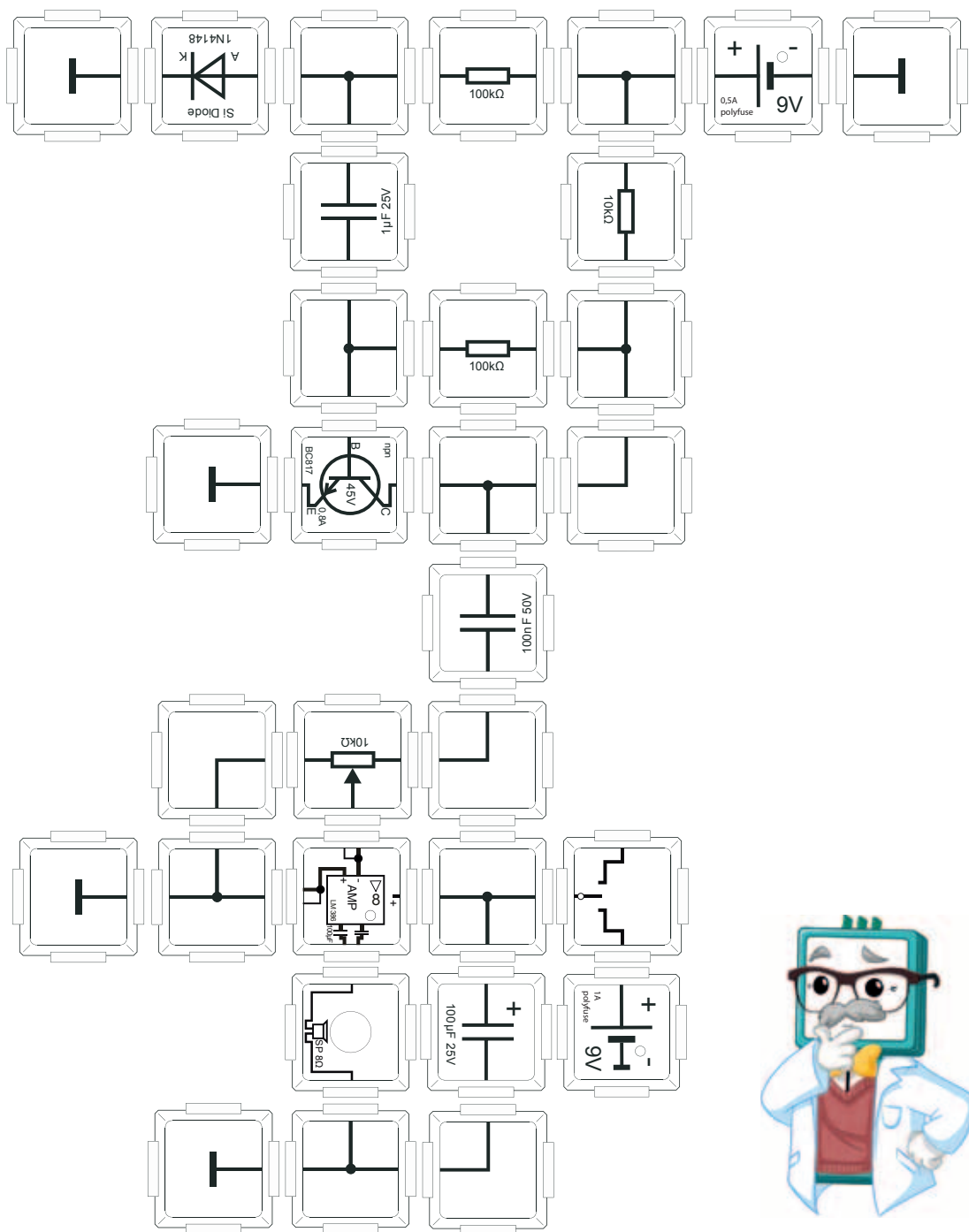

17.3 Noise generator 2

Of course also transistors are semiconductors. In the following circuit, we transform the electric noise of transistor BC817, as we have often used, into an acoustic signal. In this case only emitter and base are connected, and double of the usually voltage is used in reverse direction of the base emitter diode to get the effect. The switch must be on for the 2nd voltage to power the audio amplifier. In series the 9V are added to this volage to get the 18V for generating the noise.

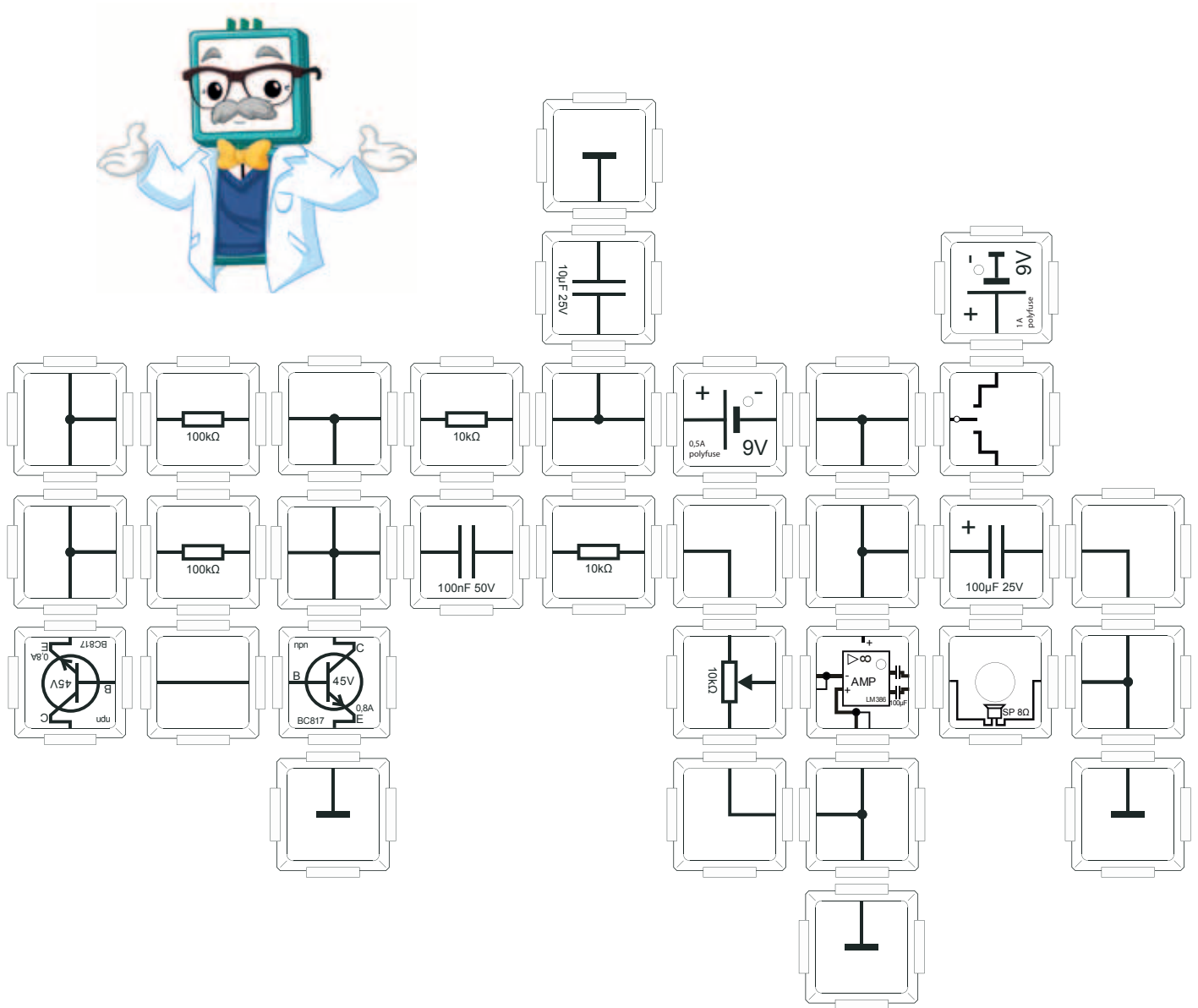

17.4 Light amplifier

In the following circuit we will make light hearable. Our eyes are too inert to perceive even low frequencies of 20Hz. Therefore we convert the light pulses, caused by the 50Hz frequency of room lights for example into acoustic signals. Florescent tubes for example cause a humming sound. The LDR03 is used as a sensor in this experiment. It changes its resistance with the impulses acting on him. They can be explained as a AC voltage superimposed by a DC voltage. The DC voltage components are filtered away by the two 1μF capacitors and the powerline AC wave is pre-amplified by the transistor. The audio amplifier LM386 makes the final amplification and allows to hear the humming sound in the speaker.

So you can go on a quest to find light sources in your home. The closer you get, the louder the sound. Lets have fun!

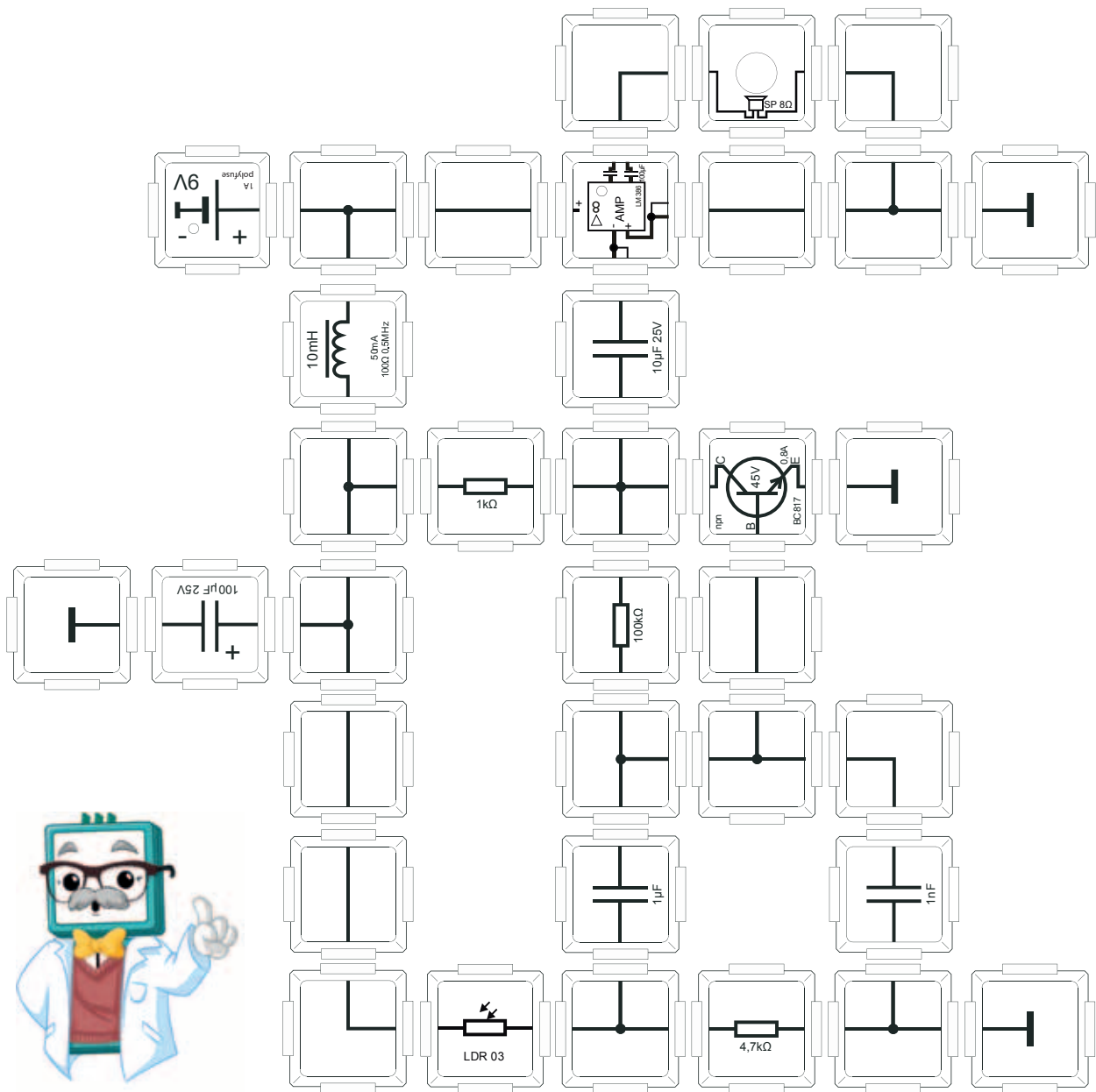

17.5 OPAMP as AC powerline detector

Another way to realize a hum-detector is described in this example.

It's more simply constructed and less sensitive but more error proof. Only the audio amplified LM386 is used for amplification of the power line wave. The 100 μ F electrolytic capacitor minimizes feedback and thus prevents oscillation of the circuit.

Note: Please check the correct polarity!

Have fun with the detection of modulated light sources.

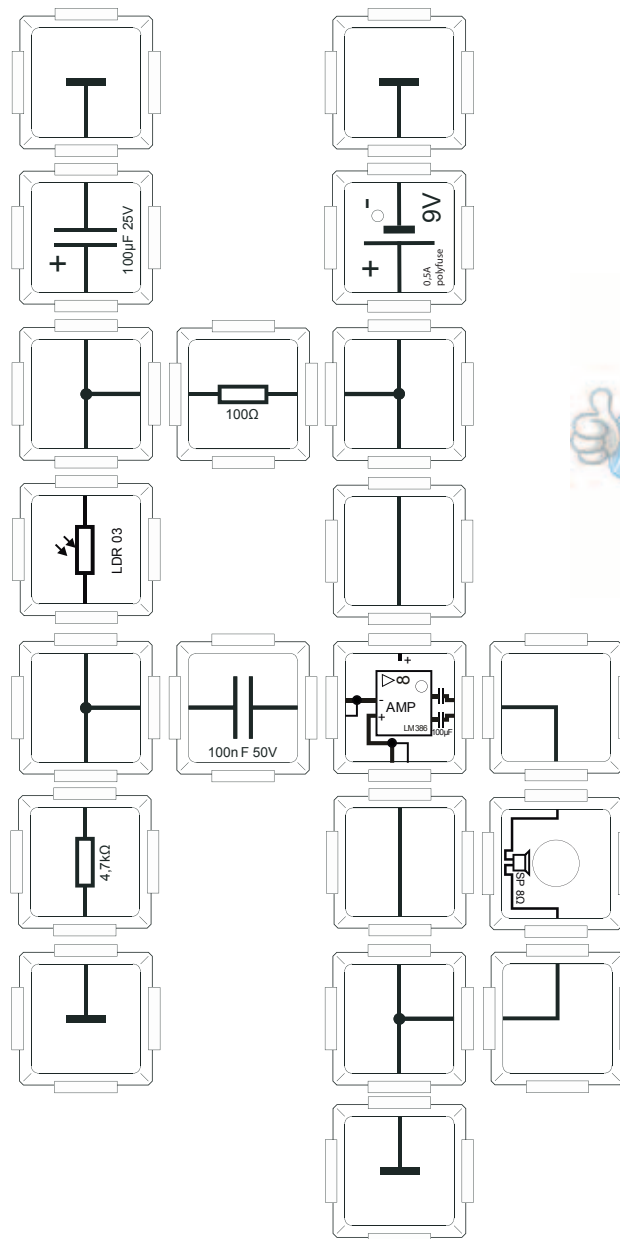

17.6 Light barrier for audio transmission

The following example shows the versatility of electrical engineering. We convert an acoustic signal four times:

1. Sound into electricity
2. Electricity to light
3. Light into electricity
4. Electricity into sound

The exchange of information is done by electronics. The brick in this experiment is called light barrier brick. It contains a infrared LED as light source in and phototransistor as a light sensor.

In total we have two amplifier stages connected in series, the first amplifier is hidden in the microphone brick as a field effect transistor used as preamplifier and the 2nd is our audio amplifier.

Now, if you scratch or whistle into the microphone, a sound can be heard coming from the speaker. You can interrupt the light barrier with a piece of paper (or metal -- be sure its infrared blocking) and the sound will get muted, until it is completely silent.

For experiment: Test different materials if they can block infrared !

Note: Please pay attention to the correct polarity.

The light barrier also serves as galvanic isolation. Therefore also a 2nd voltage source is used. Feedback through electric connections is totally avoided. But you can get acoustic feedback if there is a path from the speaker to the microphone. Try to turn the microphone part by 90 degree to get this effect.

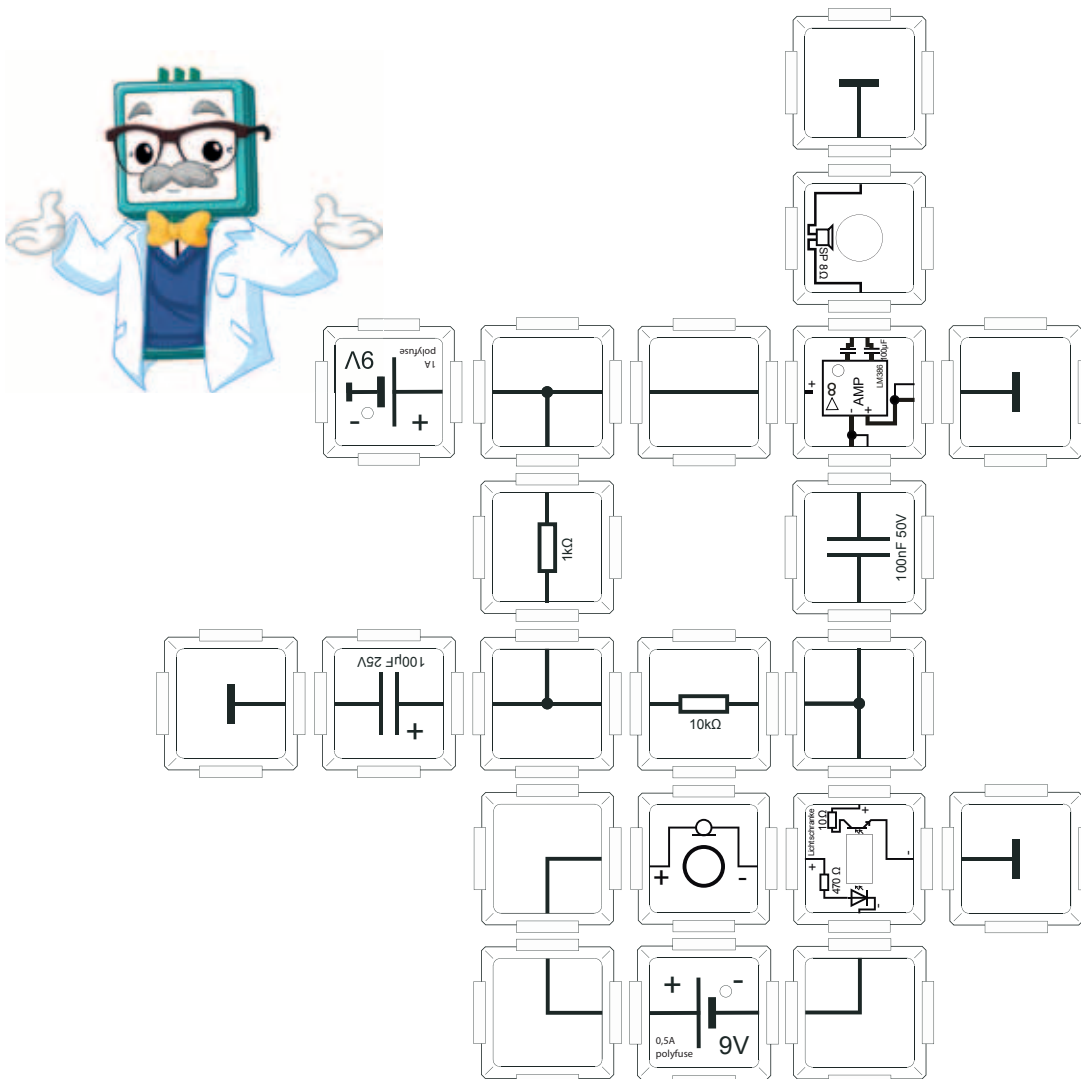

17.7 Photo transistor with preamp

To make the hum audible in a different way, we use the photo transistor instead of the LDR. Otherwise it is almost the same circuit as in experiment 17.5. We remember that the photo transistor amplifies charges caused by photons at its base. The higher the photon-current, the higher the current flow between emitter and collector. There the photon current is much easier to observe than for example with a photo diode. Please check the correct polarity of the electrolytic capacitor, which is used to reduce the feedback.

Now you can find different sources of modulated light. It's interesting to compare the different acoustic signals produced to each other, for example from a flickering light of a candle, classic light bulbs, ceiling LED lights, or neon tubes.

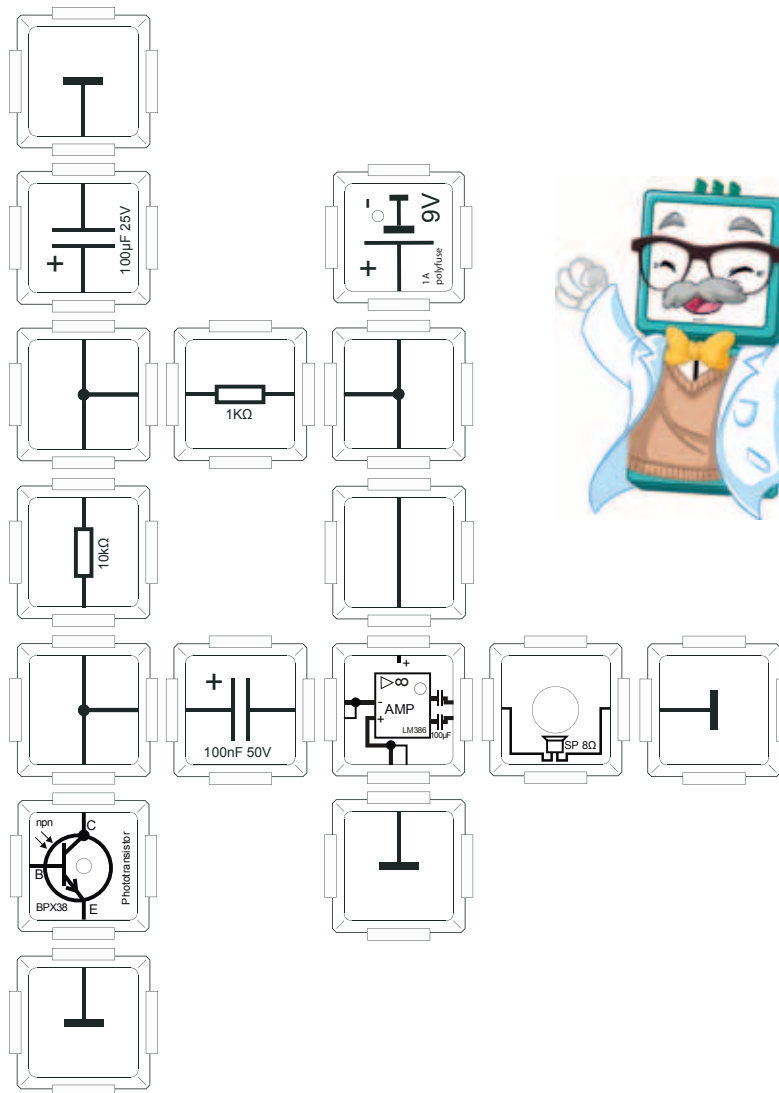

17.8 Phototransistor with infrared (IR) transmission

Our photo transistor is still sensitive to wavelengths that can no longer be perceived by our eyes, infrared light for example. It is above the wavelength of 780nm and gets into heat radiation with around 10000nm the FIR. The following circuit uses the wavelength of about 1 micron to transmit acoustic signals. We use the infrared-brick and the phototransistor instead of the light barrier to pass the signal to the audio amplifier.

The spectra of the infrared LED and the phototransistor sensitive fit together very good. With longer wavelengths, the efficiency of the transistor decreases slowly until it is no longer sensitive.

Note: Please pay attention to the correct polarity of the electrolytic capacitor! To get a successful transmission, place the infrared and the phototransistor-brick close to each other, you can also connect the bricks perpendicular to each other.

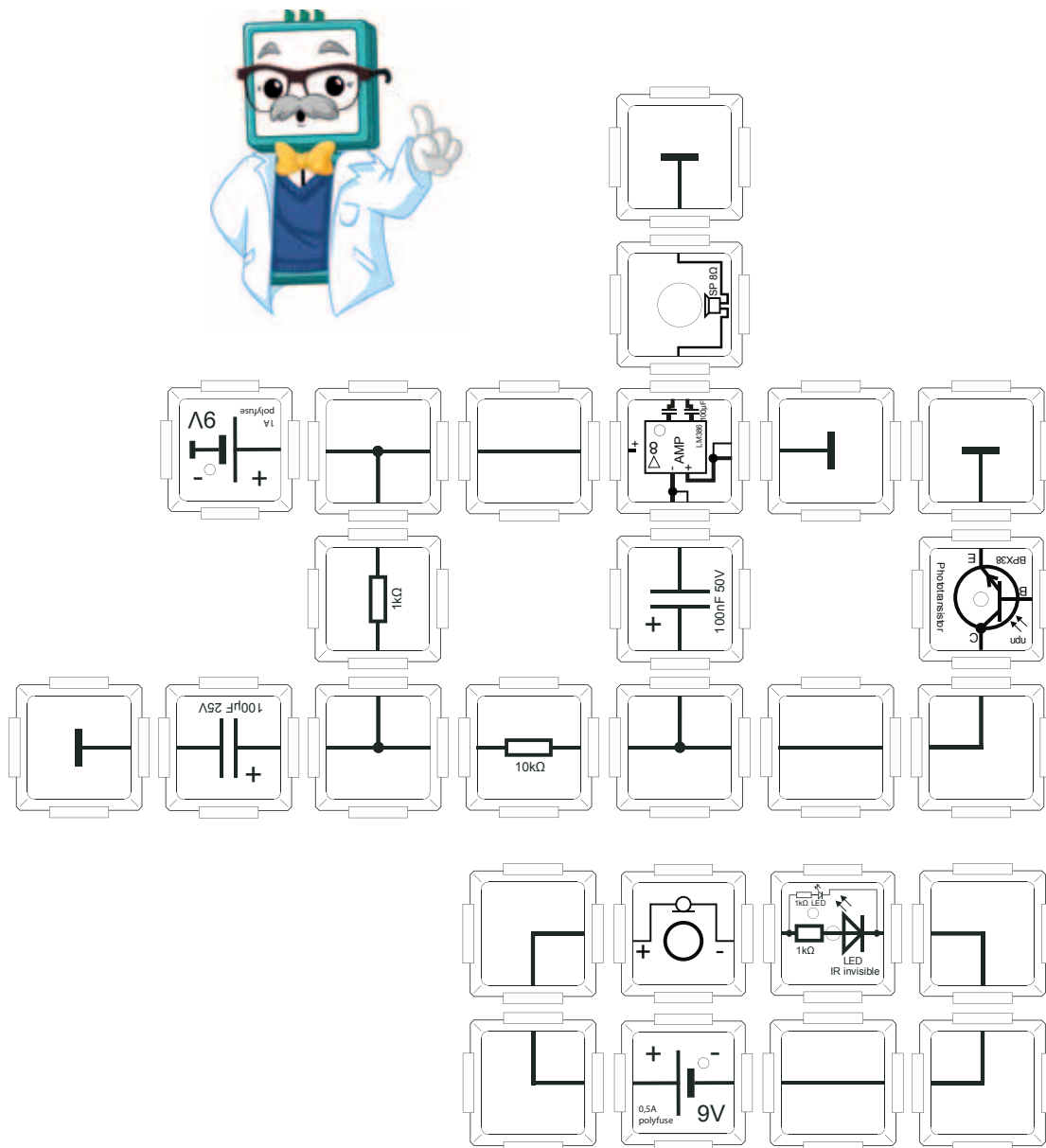

18. Relay circuits

18.1 Relay

A relay is an electromagnetically operated switch. By applying a switching voltage and resulting current flow on the input side, a magnetic field is generated by the coil that actuates the operating contacts. The transmission of the switching process by a magnetic field has the advantage, that controlled circuit is electrically disconnected from the controlling circuit. A short circuit in one circuit has no influence to the other circuits.

Our relay is very modern, because it has a protective circuit against reverse polarity and overvoltage. It operates with a minimum voltage of 5V at a current of 30mA. The control LED provides information on the switching state: The LED lights up, when the relay switches from the center to the downside. It can be used as a close to open or open to close or as toggle switch. Because of the dual contacts of our special connection, the signales can be used also seperately or together.

Relays are used very often, because they can switch very high loads. But for the transmission of large amounts of information, they are a very bad solution, due to the large switch delays when compared with electronic switches.

In this circuit the switching is done by pressing the push button. When the button is pressed, the relay is energized and the contacts are switched. This is visualized by the LED.

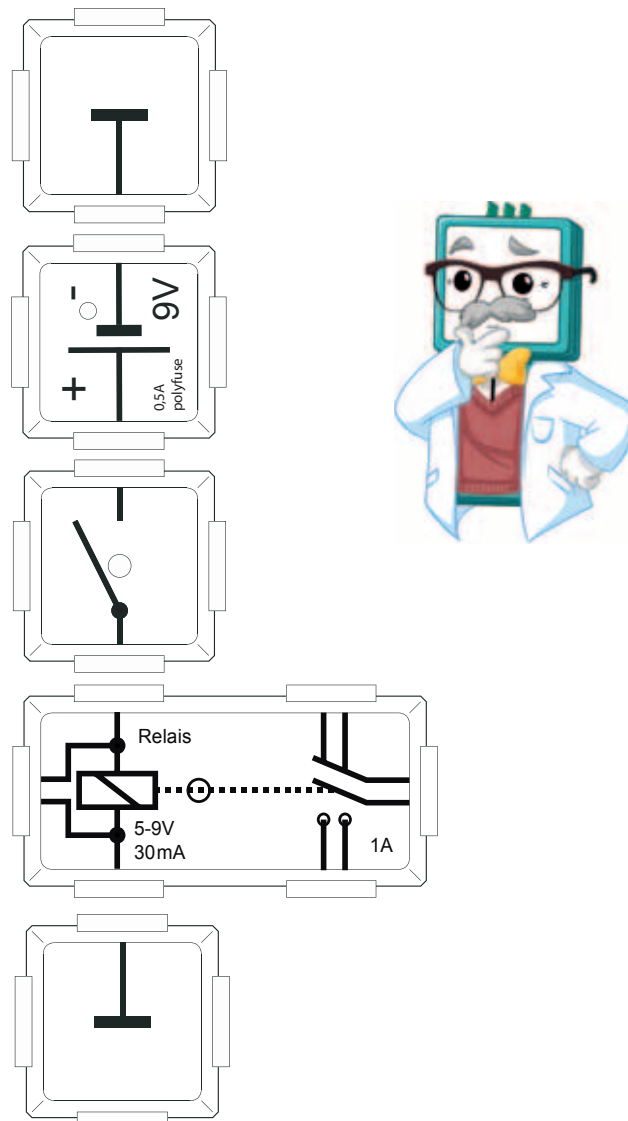

18.2 The relay as switch

In this example we use our relay as a switch. The center contact, connects either to the upper or to the lower side. The upper LED is on, when the button is NOT pressed, and the LED at the lower side (you can use a yellow one) is on, when the button is pressed. In all security relevant circuits NO-contacts are used to signal a circuit break in the event of a fault. This can easily be imagined for the red LED. The push button serves as security contact, and when normally ON (by a closed door), the LED downside is ON, for a normale condition. If the door is opened, and the button released, then the upper LED (red) gets ON and indicates a security problem.

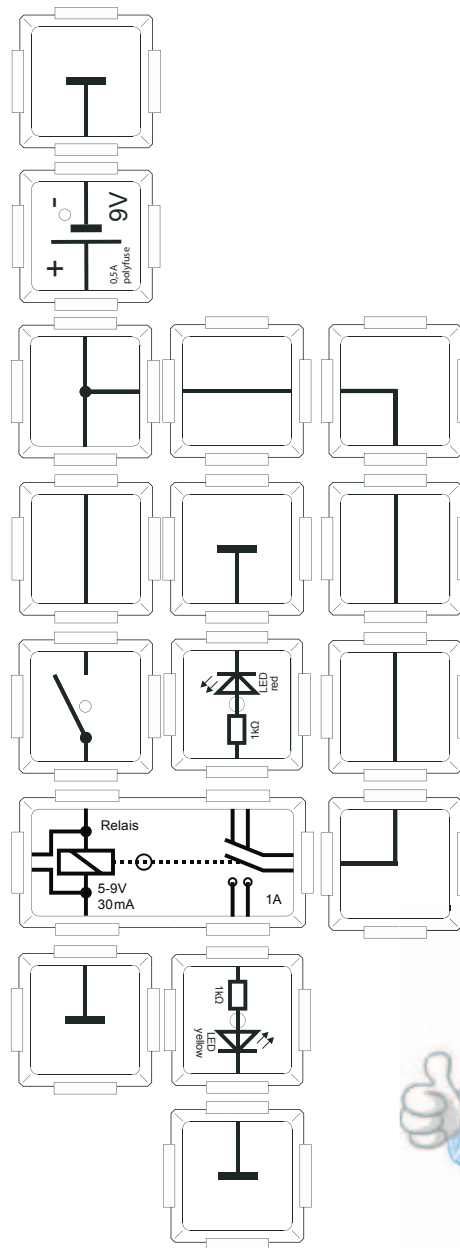

18.3 Relay in series

The minimum voltage of one relay is about half of the supply voltage, this allows to connect two relays in series. The internal resistances act as a voltage divider. Both relays are equal in design, so both operate with 4.5V. If a third relay is integrated in the circuit, the minimum voltage is no longer reached, so that the current flow is too low for operating the relay. The relays remains inactive.

Our example circuit does not really make sense, as the contacts end up in nothing and even some of the contacts are connected in some way. Its only a proof of concept design, to make curious for own experiments. When the switch is closed, both relays pull and both control LEDs light up.

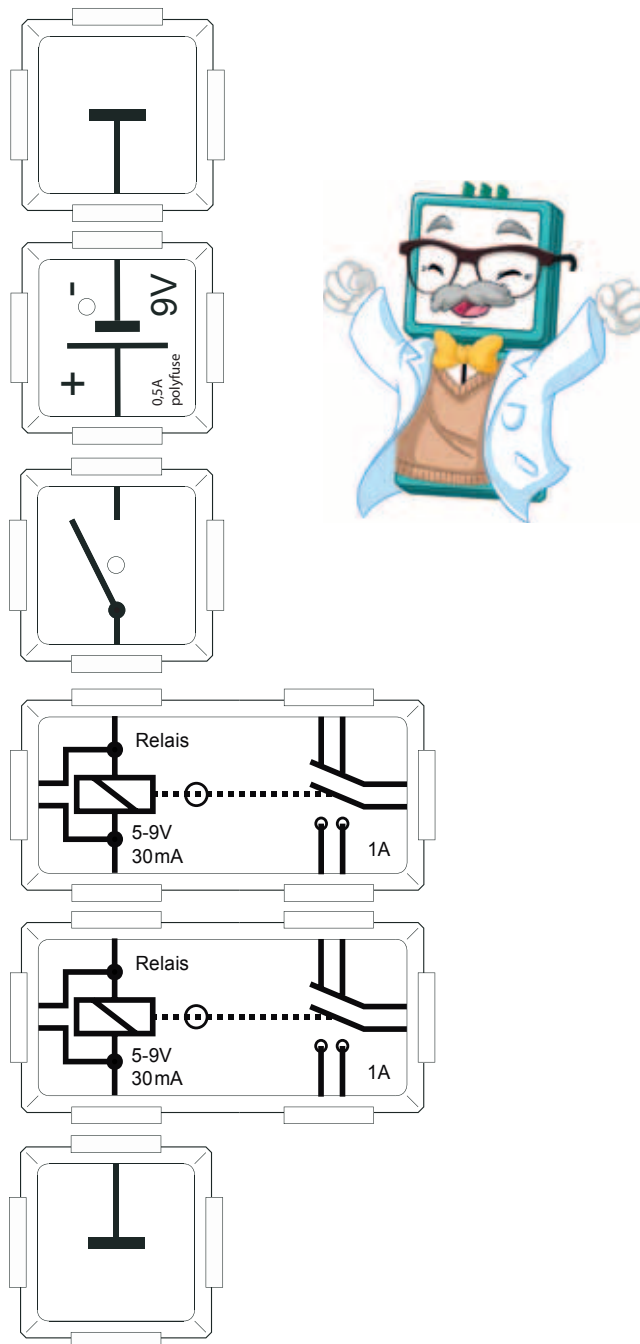

18.4 Relays in series

In this circuit, the first relay triggers the second, which then switches on the yellow LED. For controlling power plants or high voltage technology, the isolated connection of additional circuits is important. This allows to implement to convert to different voltage levels for example in a conversion power plant. The switching-cascade is triggered by pushing the button and the yellow LED indicates a current flow in the controlled „third“ circuit.

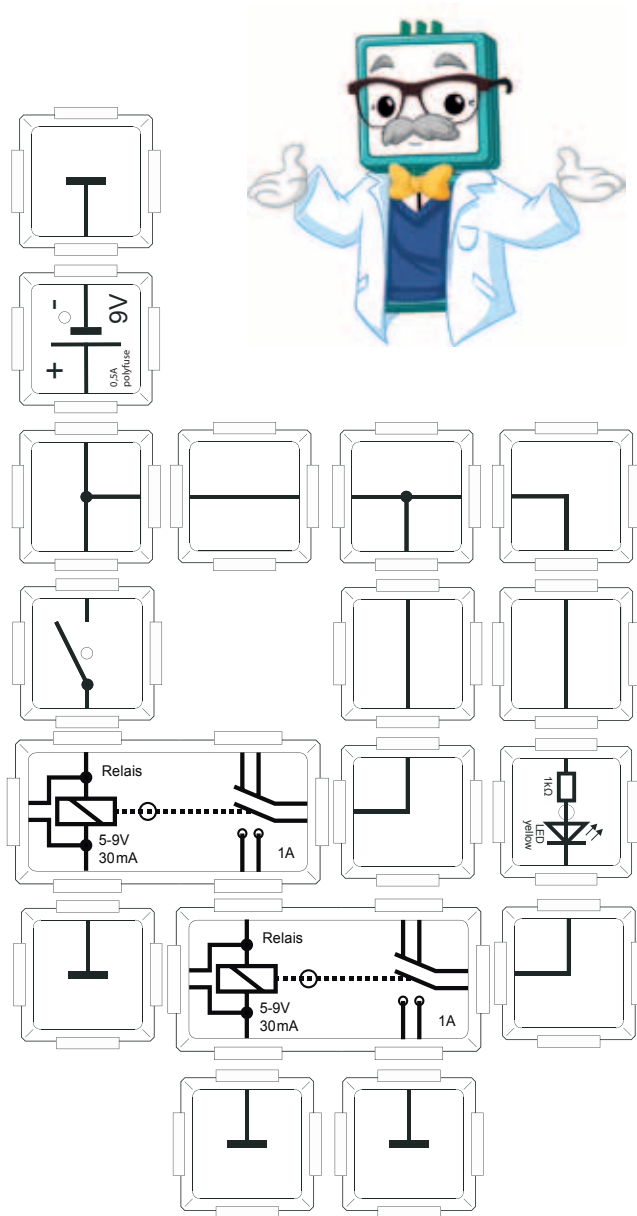

18.5 Relay in parallel circuits

A parallel connection of electronic components we have already seen in a previous examples. This can be compared to duplication or junction. In digital technology parallel circuits are implemented by OR and NOT-connections. Now we connect two relays in parallel to the circuit. This is possible because we have double contacts at one side of the relays brick. Both relays are switched on by pushing the button, therefore the number of total contacts is doubled, without having made significant changes to the circuit or adding additional switches. The voltage drop across both relay is the same and compatible to the supply voltage. The total current to switch on the relays has doubled of course. The kirchhoff law and mesh rules of electronic circuit always apply, but this is far away from our topics here.

As in the previous experiments, both relay are switched to on state by pressing the button, this is visualized by the two control LEDs.

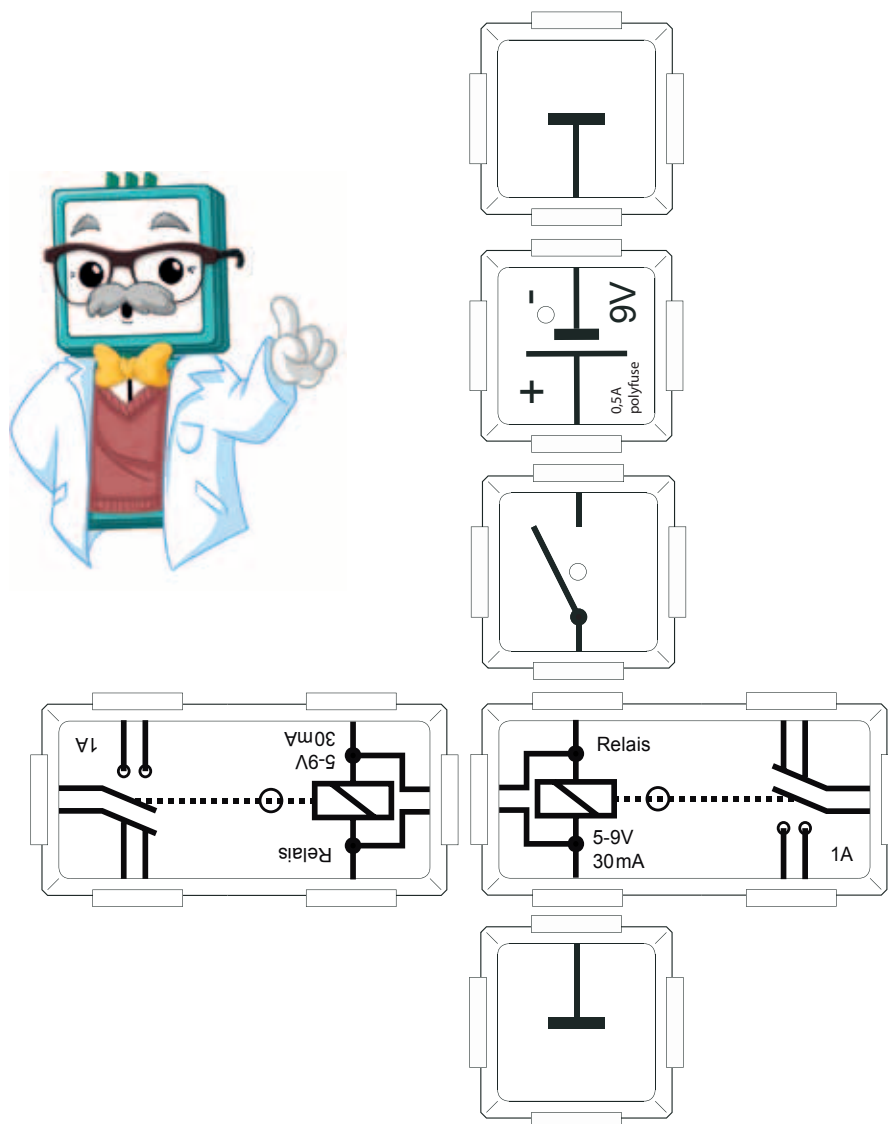

18.6 Relay in self-sustaining

The self-sustaining of relays can be found everywhere, where the switching impulse takes place only for a short time, but the controlled circuits should be kept active after this trigger. We have already used the flip-flop circuit. By use of the self sustaining circuit, its possible switch on a permanently running motor by a single push button press. For example in a milling machine. Another button is pressed for turning off.

The worker does not need to push the button the whole time, which is really difficult. Here is a basic circuit of latching the relay-brick. If the button is pressed, the relay remains activated, even if activated the control LED remains on. Only the separation of the supply voltage resets the circuit. We will improve this in the next experiment.

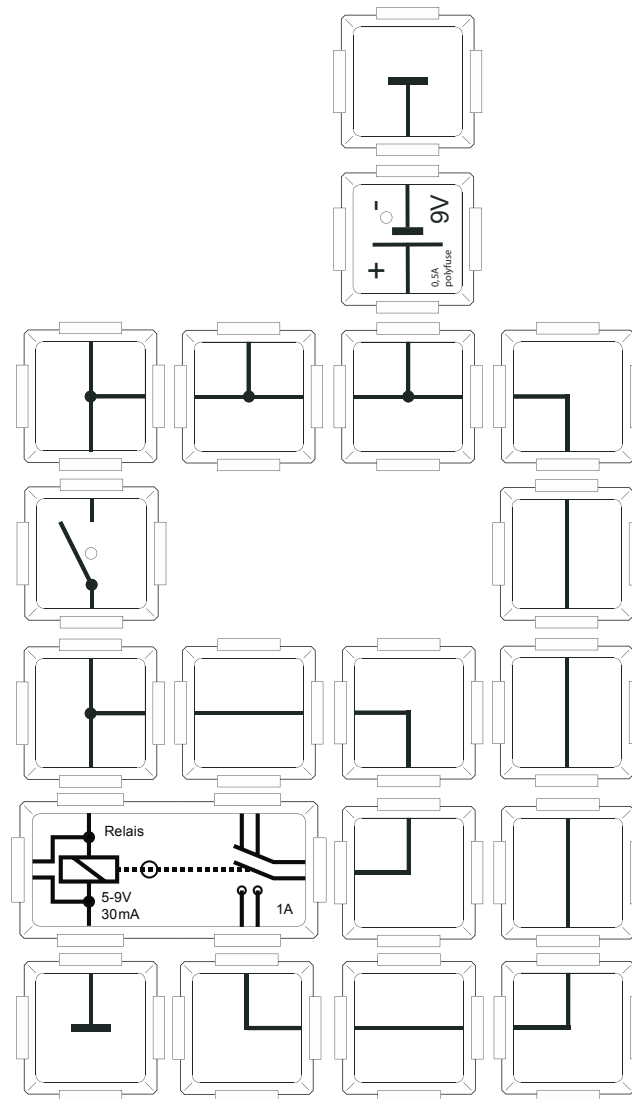

18.7 Relay in the self-sustaining with interrupter

The left relay remains active after pressing the left button, until a reset is done by using the other relay. So we have a 1-bit memory, like we did it with the electronic flip flip in the past. This can handle now the milling machine problem, we spoke about in the last experiment.

Relays can also be used as flip flop for computing purpose. In fact, the first computers were built with relays instead of transistors. One of the first computers had 1.600 relays just for the memory. It is difficult to imagine how big the computer were, compared with today's desktop computers. After pressing the left button the status LED of the left relay lights up, when the memory state is „1“. By pressing the other button, the stored information is deleted and the stored data changes again to „0“.

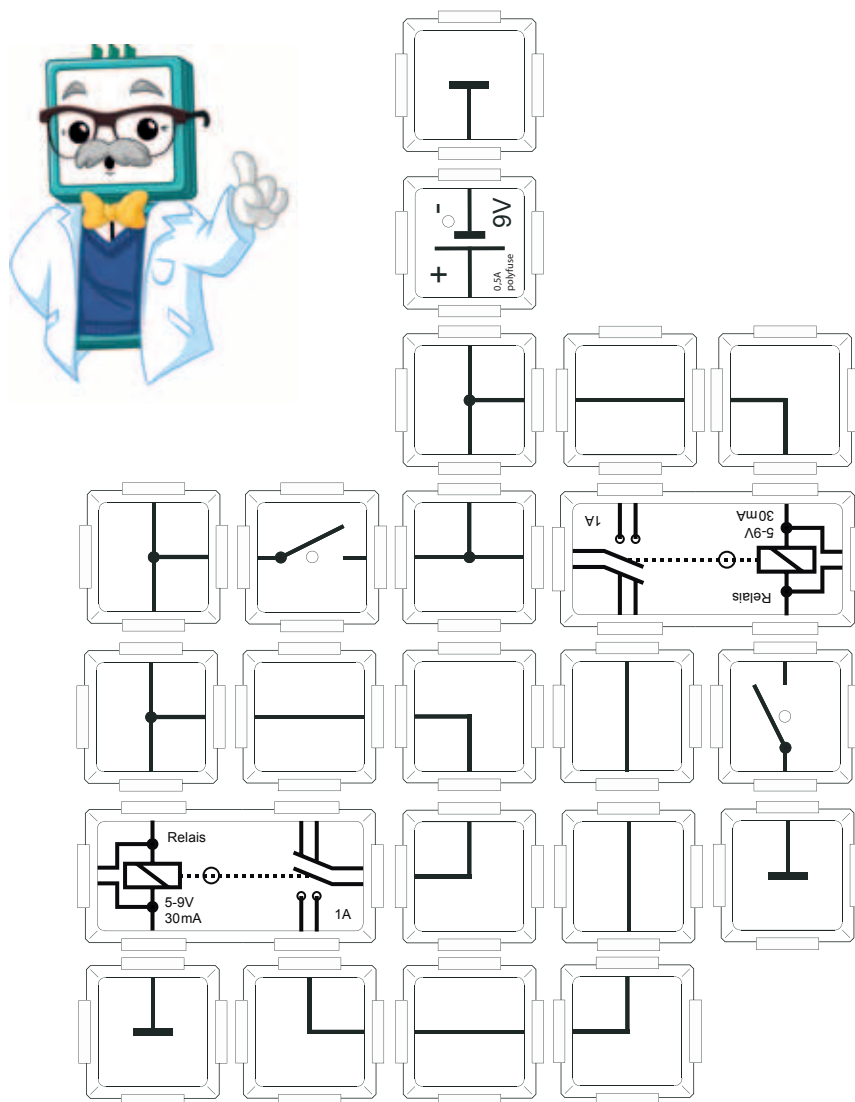

18.8 Relay with self-interrupter

The next example takes advantage of the delay between control pulse and actual switching, by a trick. If the button is pressed, a current flows into the relay, which is then activated. But this interrupts the current flow, because of the switch is connected in series with the power and the relay deactivates again. This again will activate it and so on. The process is repeated until the push button is released and interrupts the power supply.

But no worry: The relay is internally protected against damage by too rapid back and forward switching and overload. The reaction time is in range of milliseconds (e.g. 10ms). Compared to the so called gain bandwidth of a modern transistor with around 1 GHz = 1000,000,000 Hz a relay is around ten billion times slower with its 100 Hz switching frequency in this example.

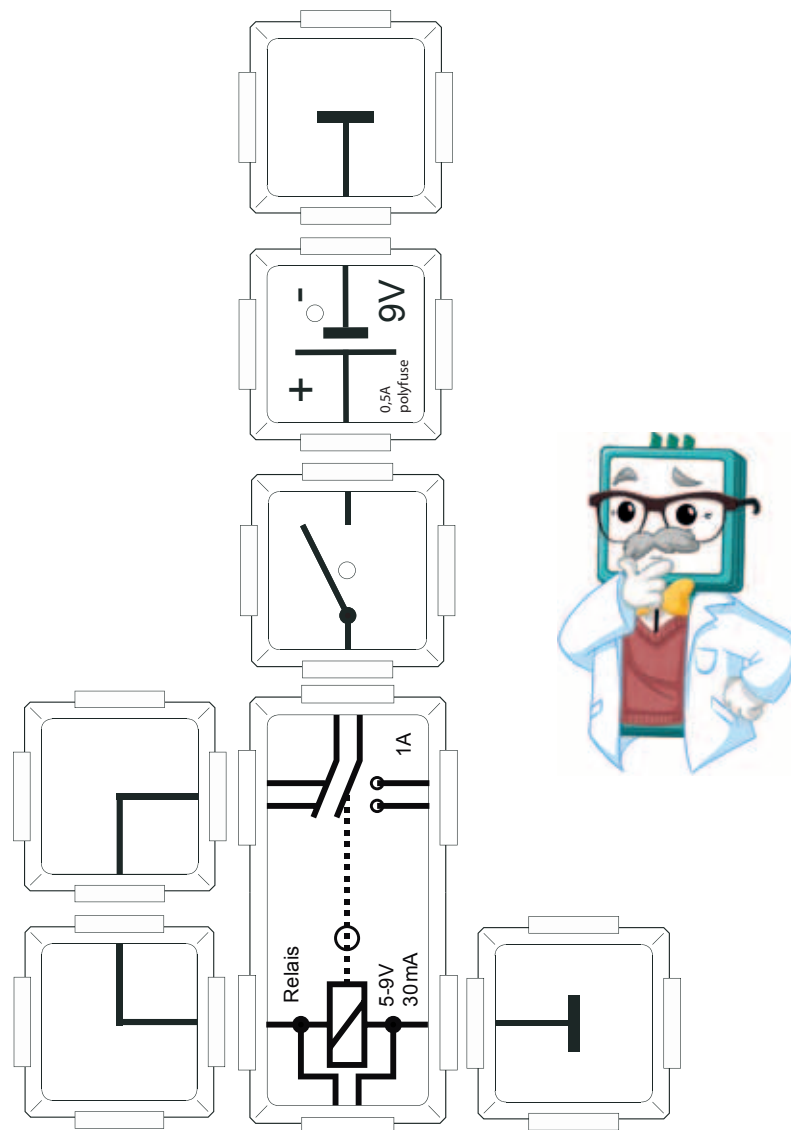

18.9 Relay with self-interrupting second relay

Now we have expanded our self-interrupter circuit with a second relay. If the button is pressed, the first relay is activated closes its contacts and therefore activates the 2nd relay. This 2nd relay as activated toggles the contacts and turns off the power of the first relay. This deactivates the 2nd relay, which turns on again the first relay and so on. To check the functionality, you can hear a hum of both relays, as well as the lighting of the control LEDs.

The process repeats, until the push button is released.

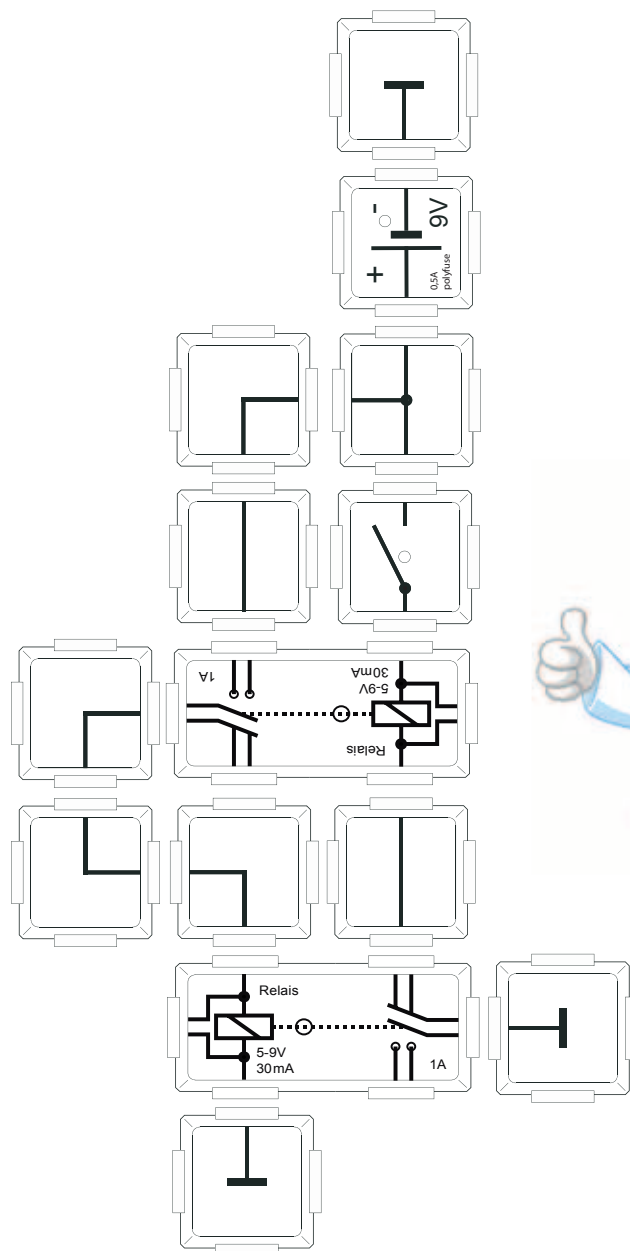

18.10 Slowly self-sustaining relay

If a capacitor is placed in parallel to the relays, a certain amount of energy is stored and the switch-on time is enlarged. The switching frequency can easily be adjusted by inserting different values on the capacitors. The capacitors store the electrical energy for a short time, even if the power supply is interrupted, so the relays deactivate if the voltage at the capacitor lower than the activating voltage of the relays.

If the push button is pressed the first relays is activated and the capacitor is also charged. After closing the contact, also the 2nd relays is activated and its capacitor is quickly charged. The 2nd relays interrupts the path to the ground of the first relays. But the first relays still gets some power throughs its capacitor in parallel. When discharged the first relays is deactivated and the 2nd relays interrupted from the main supply. But also the 2nd relays gets some energy from its capacitor which delays the decativation phase. If then the 2nd relays is deactivated, the ground connection to the first relays is reestablished and the whole processs starts again. This repeats until the push button is released.

Note: Please pay attention to the correct polarity of the electrolytic capacitor!
Try to test different capacitors.

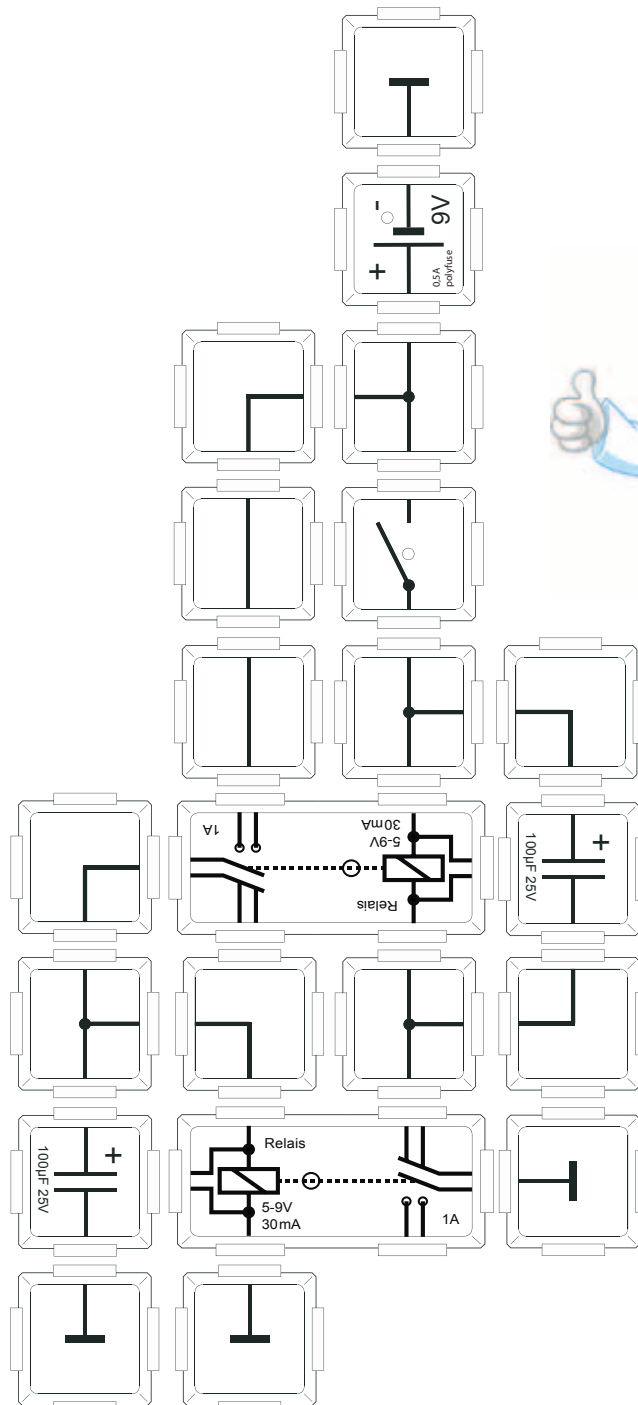

18.11 Relay (NOT operation)

In circuit 18.7 we talked about the use of relays in early computers. In the arithmetic unit of a Zuse-Computer, NOT functions have been implemented similar as we will do in the current experiment. The high level at the output is always present if the button has not been pressed. The input signal of „0“ results in an output signal of not „0“, which is „1“. Only two states are possible: „0“ and „1“. An input signal of „1“ results in an output signal of not „1“, which must be „0“. The red LED indicates the output level.

Note: In digital technology the „L“ and „H“ are used to identify the level. These can be assigned to different logical levels depending on the technology used. The most common definitions for a level range and the assignments are:

- "L" corresponds to 0 eg 0V to 0.8V and „H“ with >2V corresponds to 1, for example with standard TTL logic. Any voltage values inbetween are undefined.
- "L" corresponds to 0 eg. 0V to 0.7V and „H“ with >1.7V corresponds to 1, used for 2.5V CMOS logic.
- "L" corresponds to 0 eg. <-1.4V and „H“ with >-1.2V corresponds to 1, used for ECL-logic. Values inbetween are undefined.

If the „L“ is assigned to a „1“ instead of a „0“ and „H“ to a „0“ instead of a „1“ this is called a negative logic, otherwise its a positive logic.

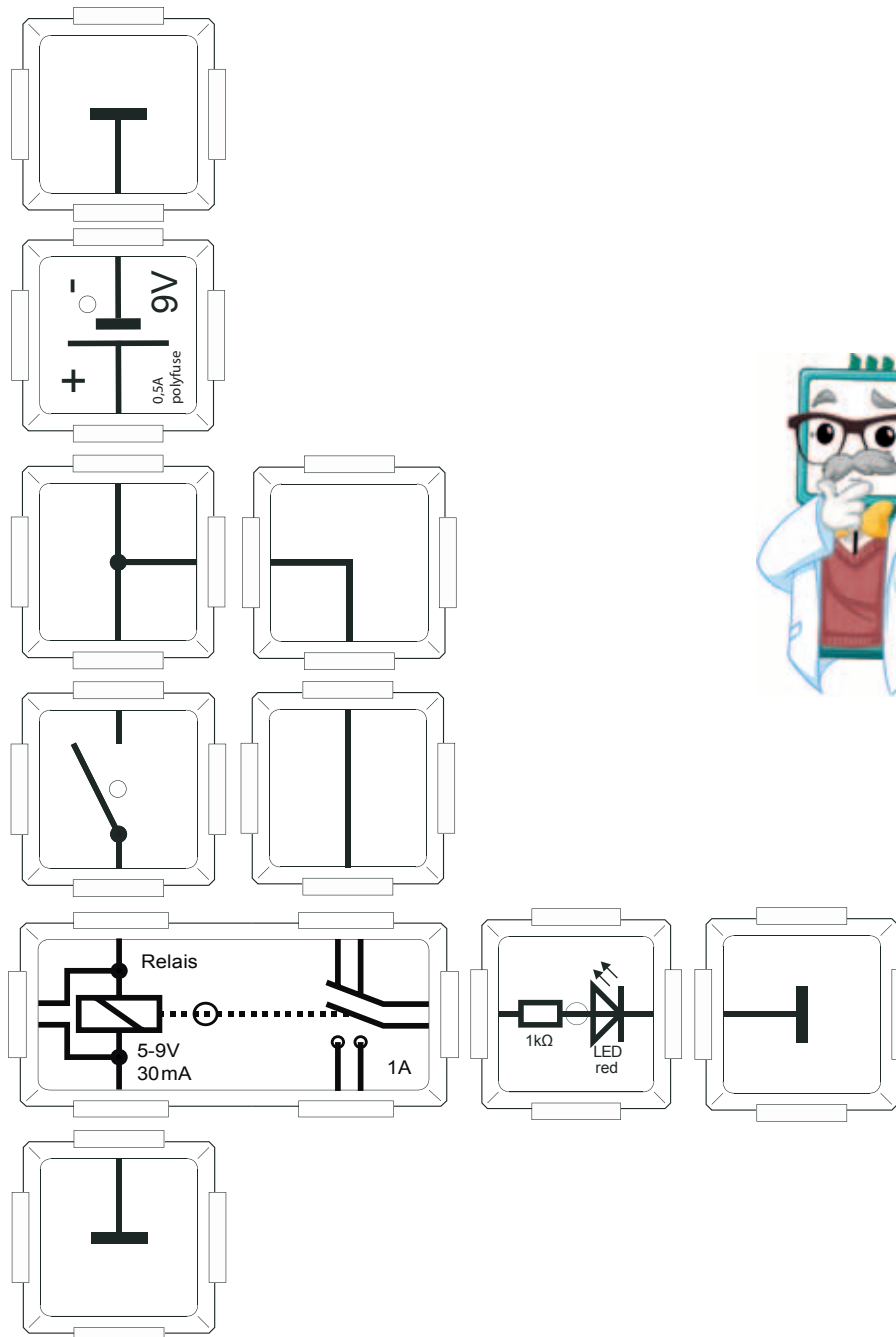

18.12 Relay (AND-operation)

The AND function can be implemented with a relay circuit as well as with a transistor (chap. 14.5) diodes (chap. 14.1) or buttons (chap. 5.1). Here, the contacts of the two relays are placed in a series, so that the output signal is only active, when both switches are closed. The experimental setup is shown in the circuit below. Similar to the other AND experiments, the LED is on if both buttons are pressed at the same time, and therefore both relays are activated. The truth table for the AND operation can be checked at chap. 5.1 or 14.5.

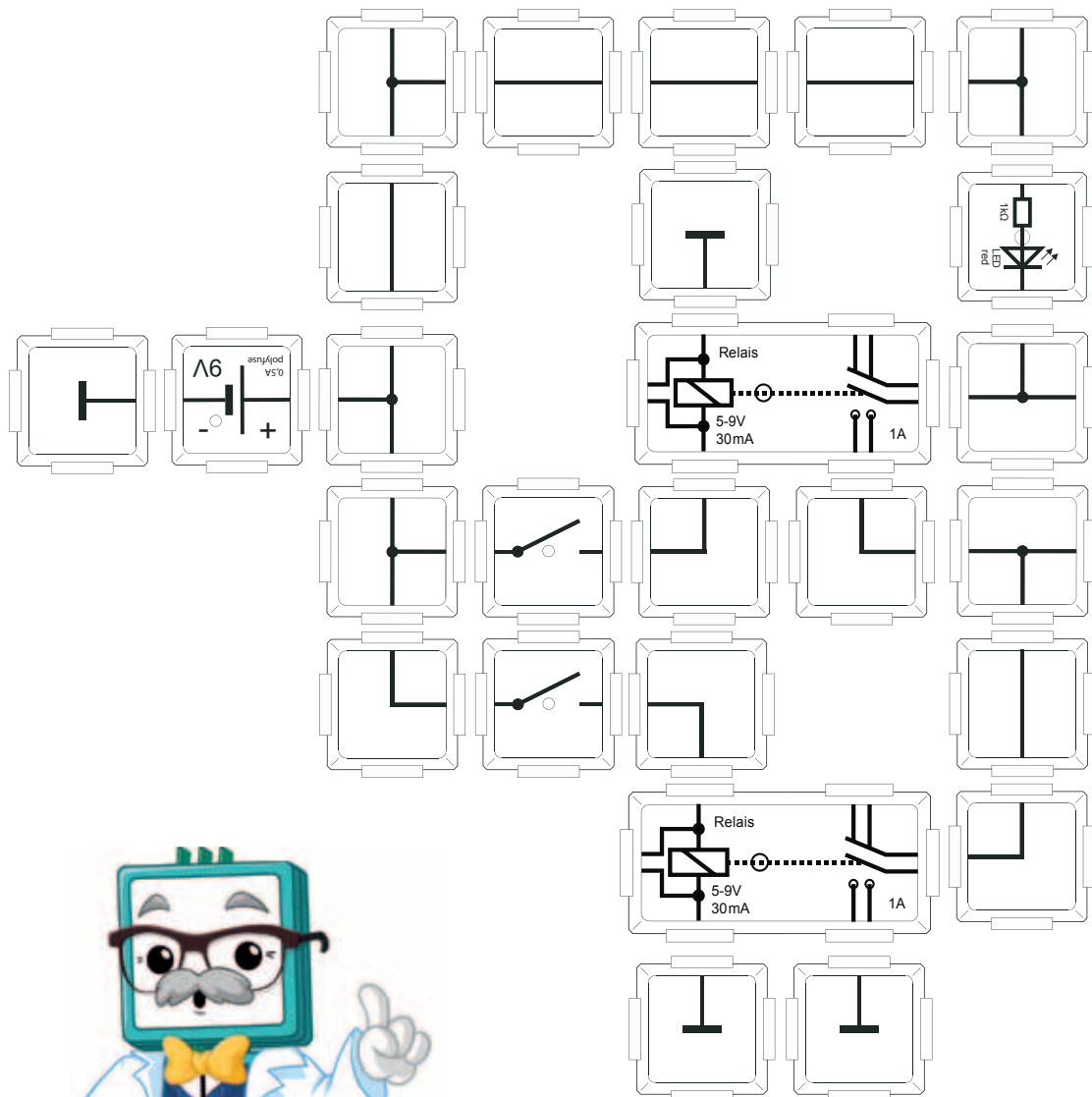

18.13 Relay (NOT AND (NAND) operation)

A NAND circuit is shown in the following example, by two OFF contacts acting as NOT, which are parallel to the LED. Only when both push buttons are pressed, the red LED turns off and a low level is present at the output. The relays wiring uses the opening function of the switches. The truth table and further information about the NAND can be found at chapter 14.3.

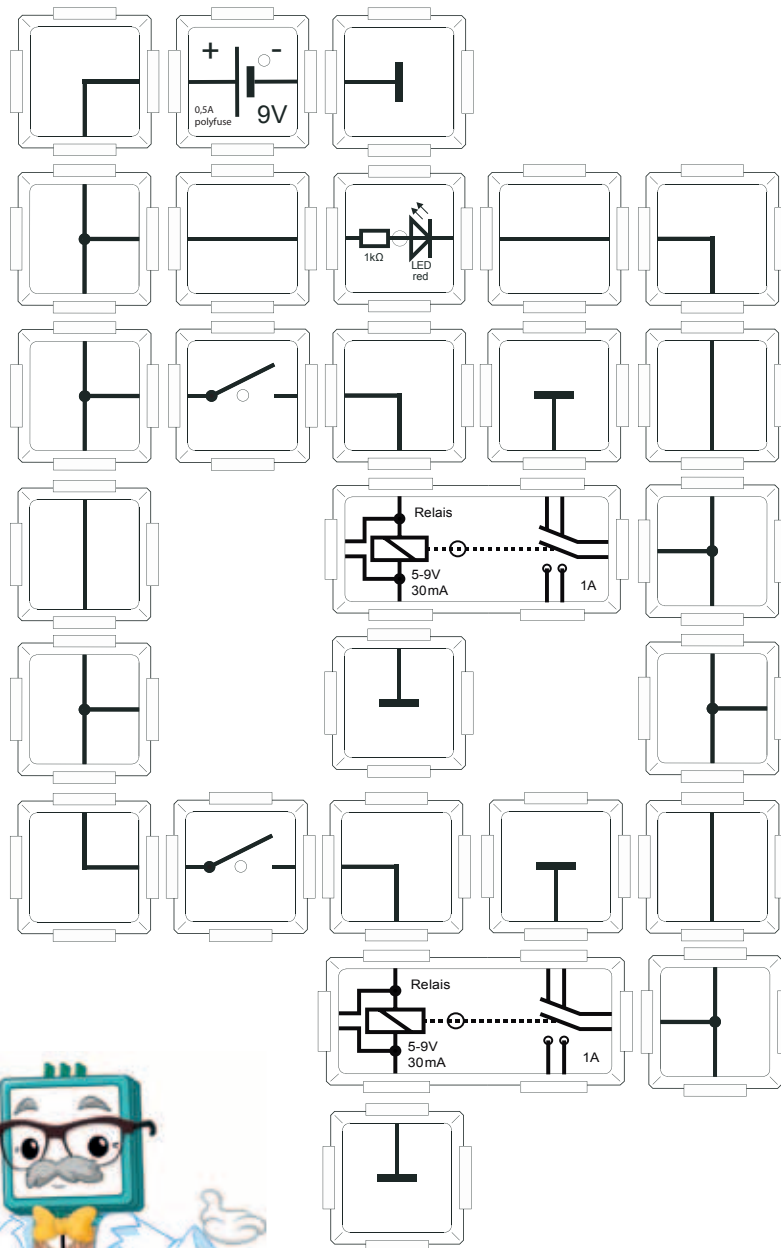

18.14 Relay OR operation

Who has understood the basic principles of digital technology, can easily create a OR circuit from the example 18.13. Example 18.13 can easily be modified to implement the OR function.. To do so, you can reverse the two working contacts of the relays and use them as a active closing contact. Only the ground-brick need to be connected to the opposite side of the relay brick. The red LED turns on when one button or the other button or both buttons are closed, resulting also in activating the correspondent relays.

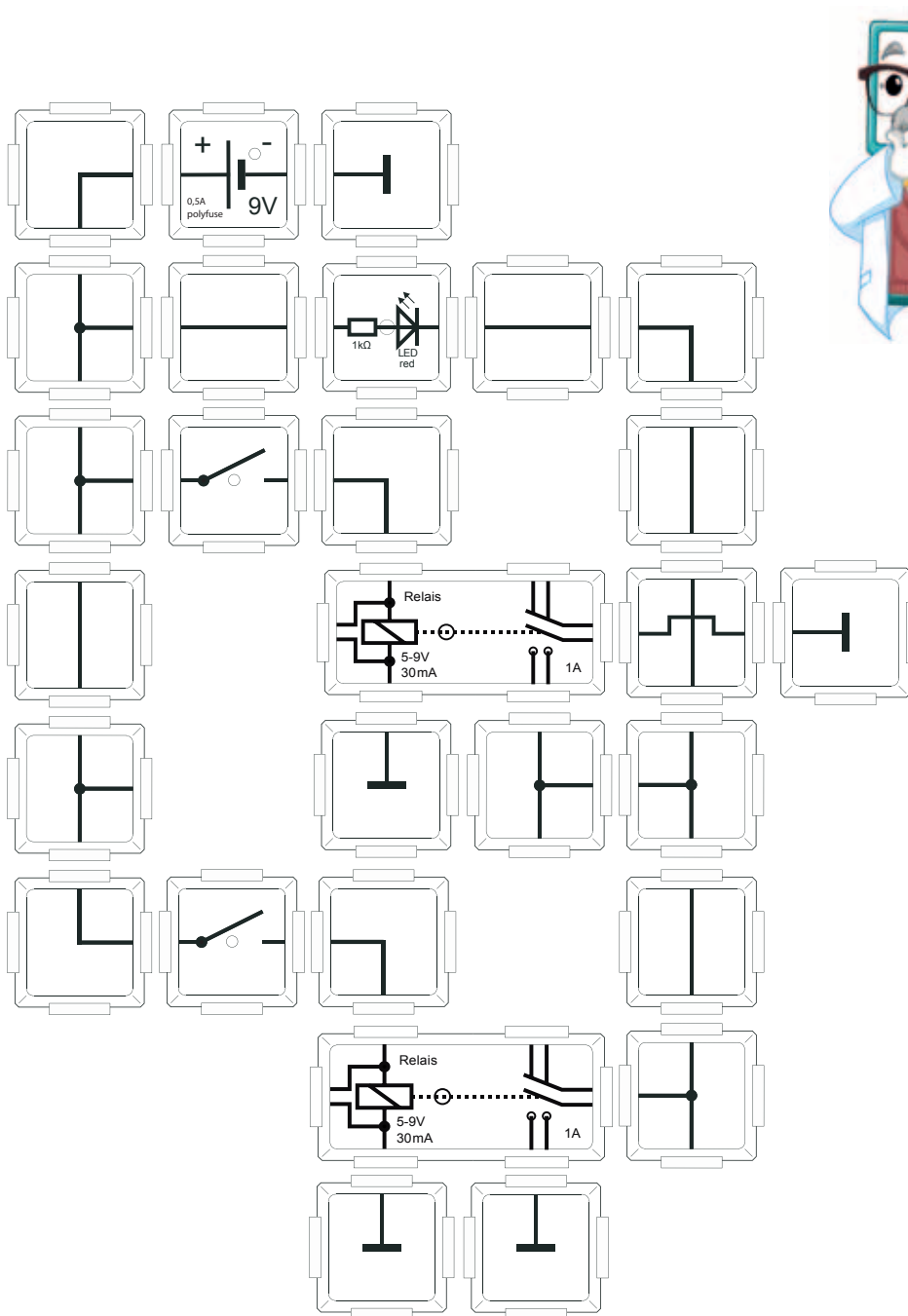

18.15 Relay NOT OR (NOR) operation

We have already seen the similarities of the NAND and OR operations. Now we negate the circuit from example 18.14. The working contacts are integrated as opener in the circuit, so that the output signal is only active when both contacts of the relays are open and the current flows to the ground. There is only one combination of input signals where an output signal is active high, that is only when no button is pushed. The truth-table to this NOR combination can be found at chapt. 14.4 which describes an alternative NOR combination at transistor-level.

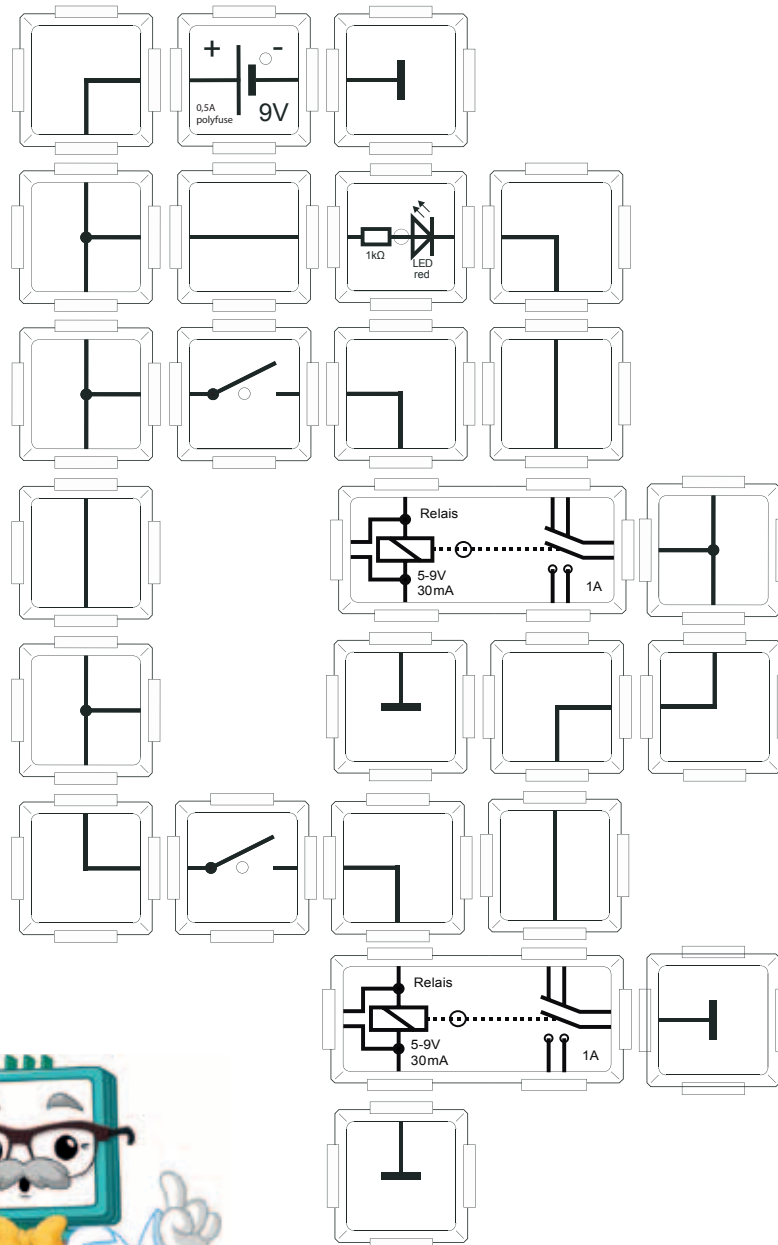

18.16 Relay Exclusive-OR (XOR) operation

The exclusive OR is implemented by using two toggle switches. Our relays have both a active on and and active off contact, which can be used for this purpose. That's why all three connections are used for implementation. The red LED lights up only when one or the other button is pressed. If both are pressed or both are not pressed at the same time, the LED does not turn on. Only different input signals result in a „high“ level at the output. The truth table and further information about XOR can be found at chapter 5.4.

As further brainteaser at this point, try to construct an exclusive NOT OR and an exclusive AND, what the true table?

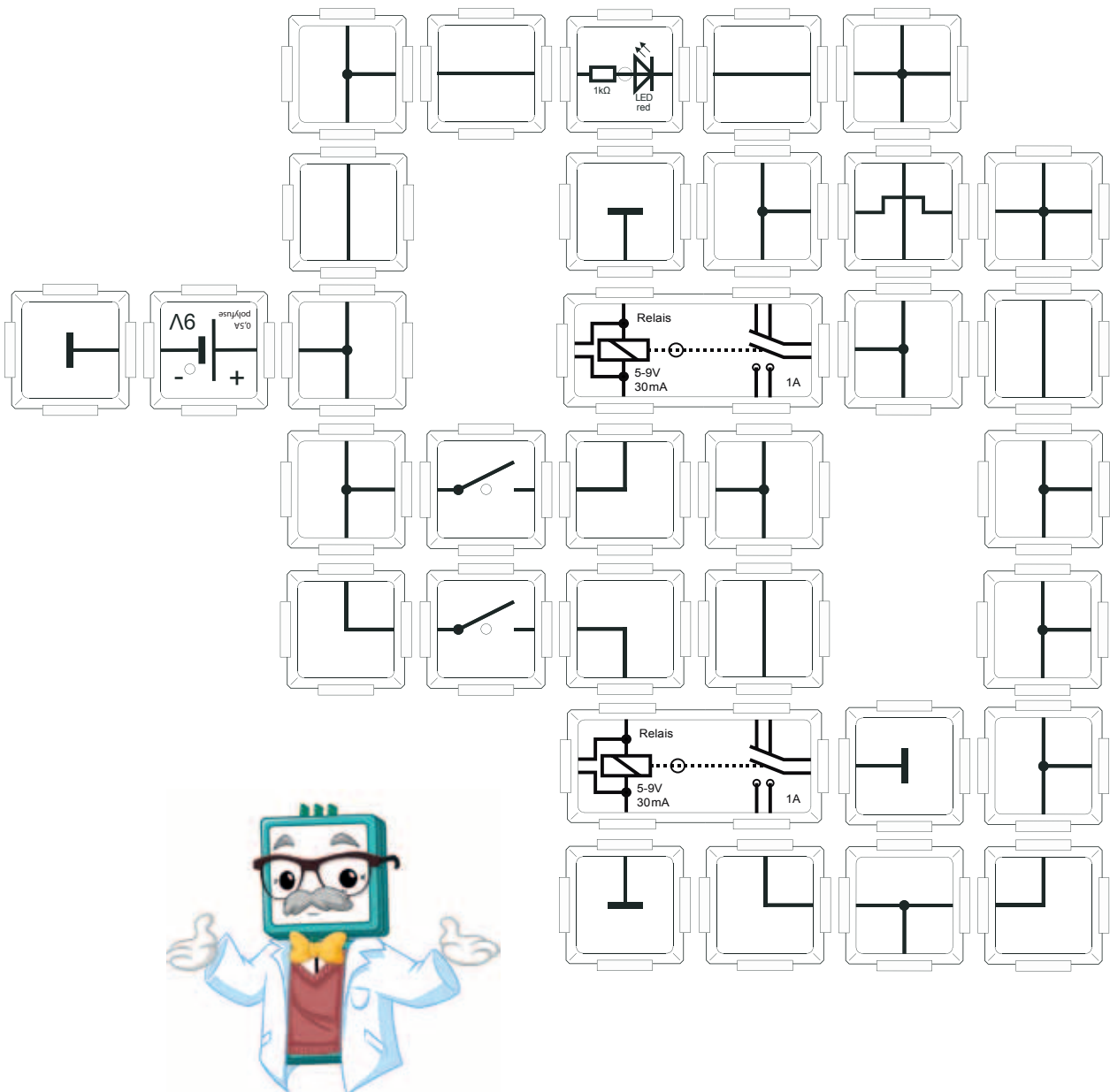

19. Reed Relay

19.1 Reed Relay

Attention: The reed relays consist of a small glass tube which can be easily damaged! The tube contains a magnetically biased contact, which switches under the influence of a magnetic field. The magnetic field must be opposite to the internal field. The experiment is done by using a series circuit of a battery brick, the reed relays brick and a LED. All connected with two ground bricks at the end. The reed relay is activated with a bar magnet. The magnet can close the contact and the LED turn on, when applying the magnet in the correct orientation. Reed relays are for example used as proximity switches for metal objects.

In notebooks reed contacts are installed to switch off the display, when the notebook is closed. The reed relays can be used without a lot of wearout due to its simple construction, in opposite to other mechanical systems.

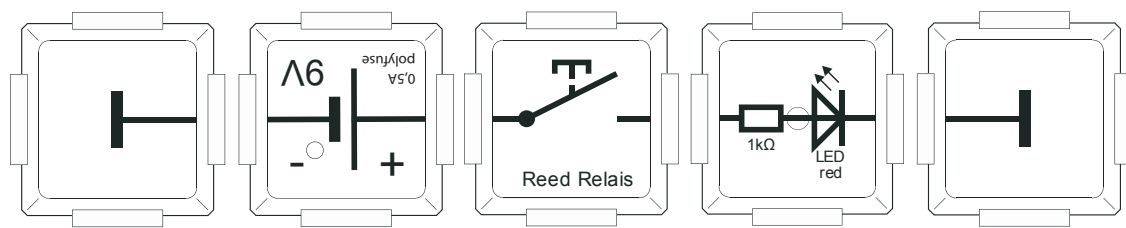

20. Buzzer - Morse circuit

A buzzer is an acoustic signal generator, with a lower bandwidth than a speaker. The buzzer can be very loud, when inserted with the correct polarity. The example shows the correct arrangement of bricks. If the button is pressed, a loud and bright beep can be heard. This circuit can be perfectly used for morseing.

Transmitted by rapid sequences of short and long tones, letters and numbers can be transmitted. The most common known signal is the „SOS“ (...---...). This signal was used in former times as an emergency signal in seafaring

The morse code was developed in the early 19th century by Samuel Morse and made it possible to transmit information over long distances. The simplicity of the code made it possible to transmit the information via telegraphing. Today the morsecode is still very popular among ham radio users. You can listen to SDR stations using CW at www.websdr.org

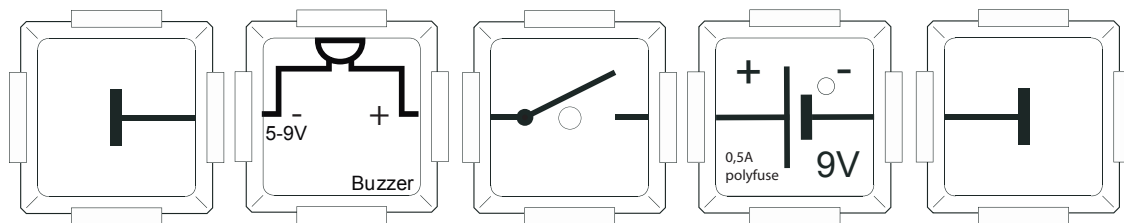

Characters - Morse Code

A	. —	S —
B	— ...	T	— .	, — — — . . — — —
C	—	U	. . —	? . . — — . . .
D	— . .	V	. . . —	" . — — — — . . .
E	W	. — — —	! — . . — . — — —
F	X	— . . . —	/ — — — . . .
G	— — . .	Y	— . — — —	(— . . — — . . .
H	Z	— — . . .) — . — — — . —
I	0	— — — — —	&
J	. — — — —	1	. — — — —	: — — — —
K	—	2	. . — — —	; —
L	. — . . .	3	. . . — —	= — — —
M	— — — —	4 —	+ . —
N	—	5	- — — — —
O	— — — —	6	—	" —
P	. — — — .	7	— —	\$
Q	— — . . .	8	— — — — . . .	@
R	. — . . .	9	— — — — . . .	



21. Alarm systems

21.1 Alarm system 1

Alarm systems must be designed to trigger in an emergency. Therefore it makes sense to implement a power interrupt activation circuit. For this we use our reed contact as sensor which activates a relay. This can be used, for example at a closed door, releasing the contact, when the door is opened, activates a signaling device by its NOT operation. In the circuit below, the relay is activated when the reed contact is closed.

The working contacts are used as an opener, that is used to implement the NOT function. If the relay is deactivated/open, this is signaled by the buzzer. At the door which should be checked, a small bar magnet activates the reed contact, as long as the door is closed. The system triggers also if the signaling wires are cut through. The power supply must be close to the buzzer and is not allowed to be intruded.

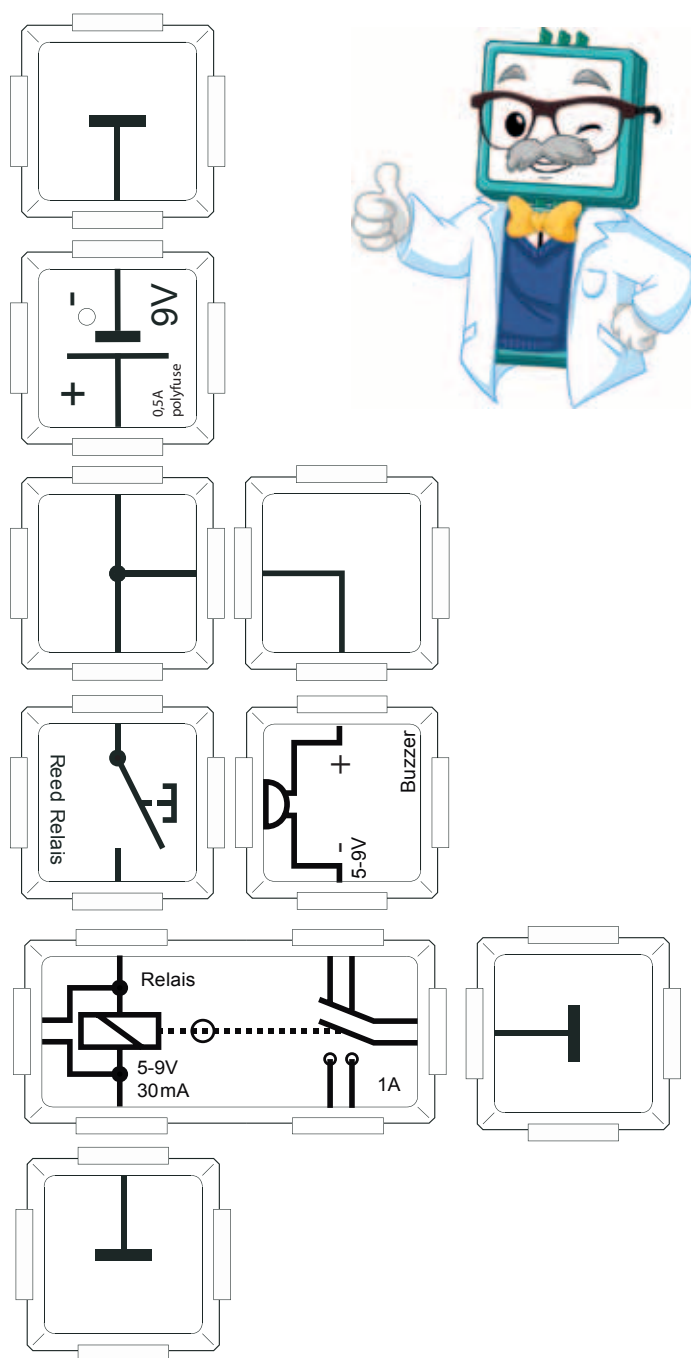

21.2 Alarm system 2

Sometimes its interesting to visualize the close state of an alarm system instead of the alarm only, for example in a control room. In this case we can use a simple transistor circuit instead of the relais last used. When the reed contact is closed the transistor is active and the current flows into the LED, which turns on. The red LED acts like an optical signal indicator.

Now you get feedback about the state of a windows, which must be closed under all conditions. There must be a magnet connected to the window, controlling the reed relay. If the window is opened without authorization, the reed contact is deactivated and the transistor also deactivates which turns of the LED in the control room and indicates the potential danger. This for example, can be used for industrial manufacturing under clean room conditions.

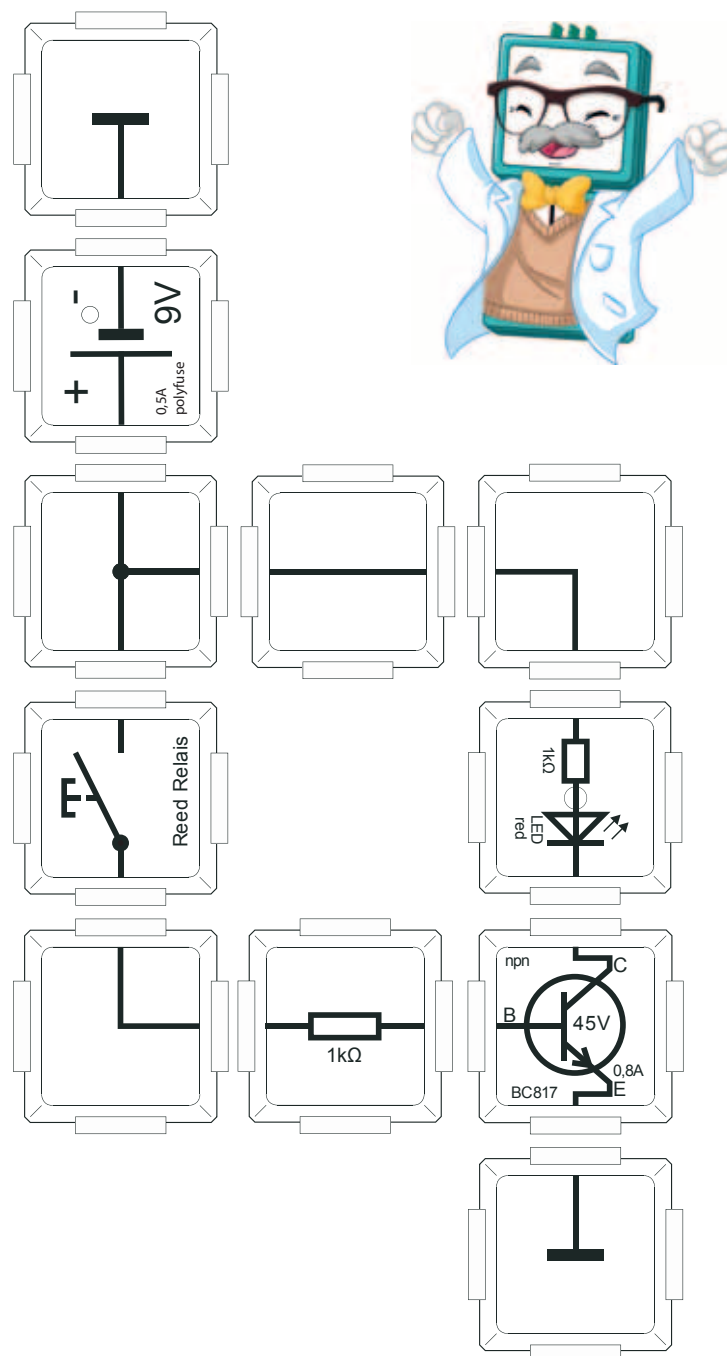

21.3 Alert system 3

Compared to previous experiments, we replace the reed relays by a 10kOhm resistor. The reed contact is not connected to switch the ground level to the base of the transistor through a 1 kOhm protective resistor if closed. As soon as the reed contact opens, a current flows into the base through the 10 k Ohm + 1 k Ohm resistor and the LED turns on indicating an OPEN CONTACT or ALARM condition. This is just reverse to the previous experiment.

This can be used for a simple overflow protection of a water tank for example. A reed contact is then closed when it reaches a certain level (by a swimming magnet -- try to built one) and then a pump is activated for example to drain out the additional water till a lower level is reached. Some delay might be needed to add to avoid switching on or off all the time - Nice experimental setup.

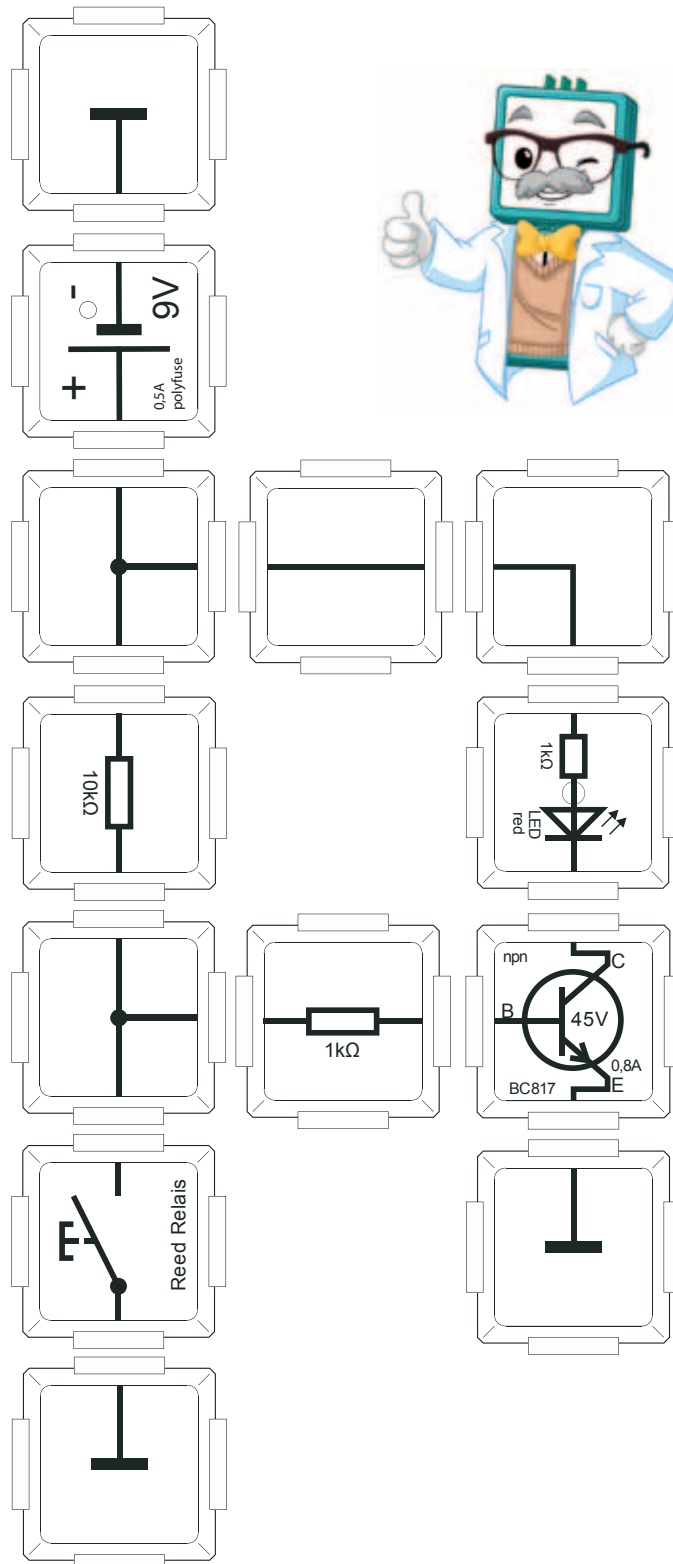

21.4 Light barrier 1

Light barriers are used as an optoelectric sensor in many technical applications. They are easy to handle, very precise and use little energy. Light barriers are often used to detect obstacles. The system automatically interrupts its operation as long as the object, blocks the transmission to the sensor.

A light barrier can prevent the closing of a door as long as someone is still in the closing door area. Often used in elevator doors for example. In our example we use the green LED as an indicator. The green LED is ON as long as the light passes through the light barrier and is NOT blocked by any obstacle. A light blocking obstacle will turn it off.

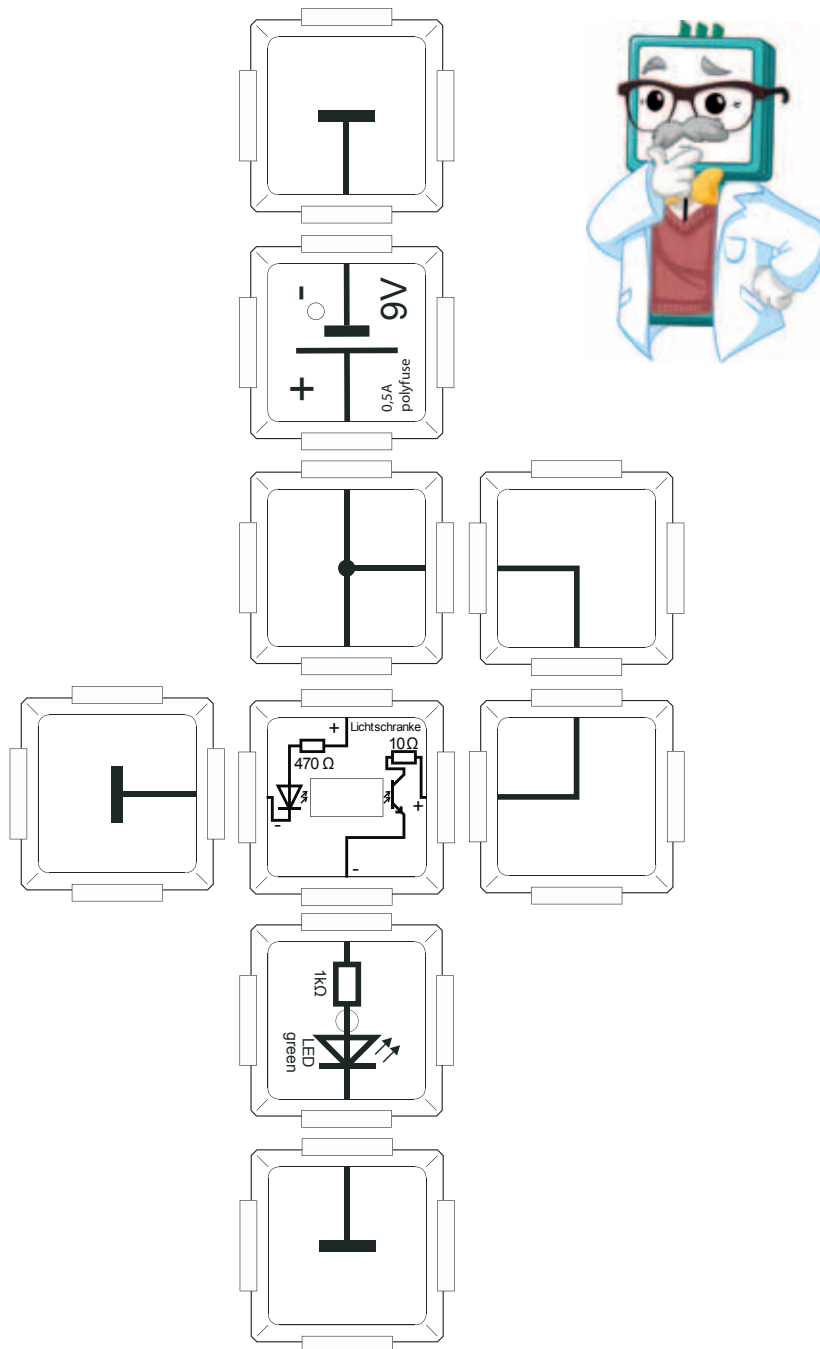

21.5 Light barrier 2

The transmission of the information can also be implemented using light barriers and their galvanic isolation properties. The example below, shows two separate circuits, that are optically coupled. This has many advantages, for example, alarm systems must work correctly, even if they have been cut from power-supply. This is important, because often the power supply is cut by burglars. The galvanic isolation is a lack of a common reference potential between two or more power circuits. Charge carriers can not be exchanged, so a short circuit in one circuit does not lead to a short circuit in the other one. That is why we have used two different voltage supplies for circuits. One is used for the transmitting LED and the second for the phototransistor and the green LED used as signal indicator. If the transmitting LED is interrupted or blocked in the first circuit, the green LED turns off with a small delay.

A 2nd advantage of this circuit is the galvanic separation of the two circuits. Its sometimes much easier to adapt the functionality of two different circuits by using an optical isolation than other methods like a transformer. (autotransformers with a tap are not isolated!).

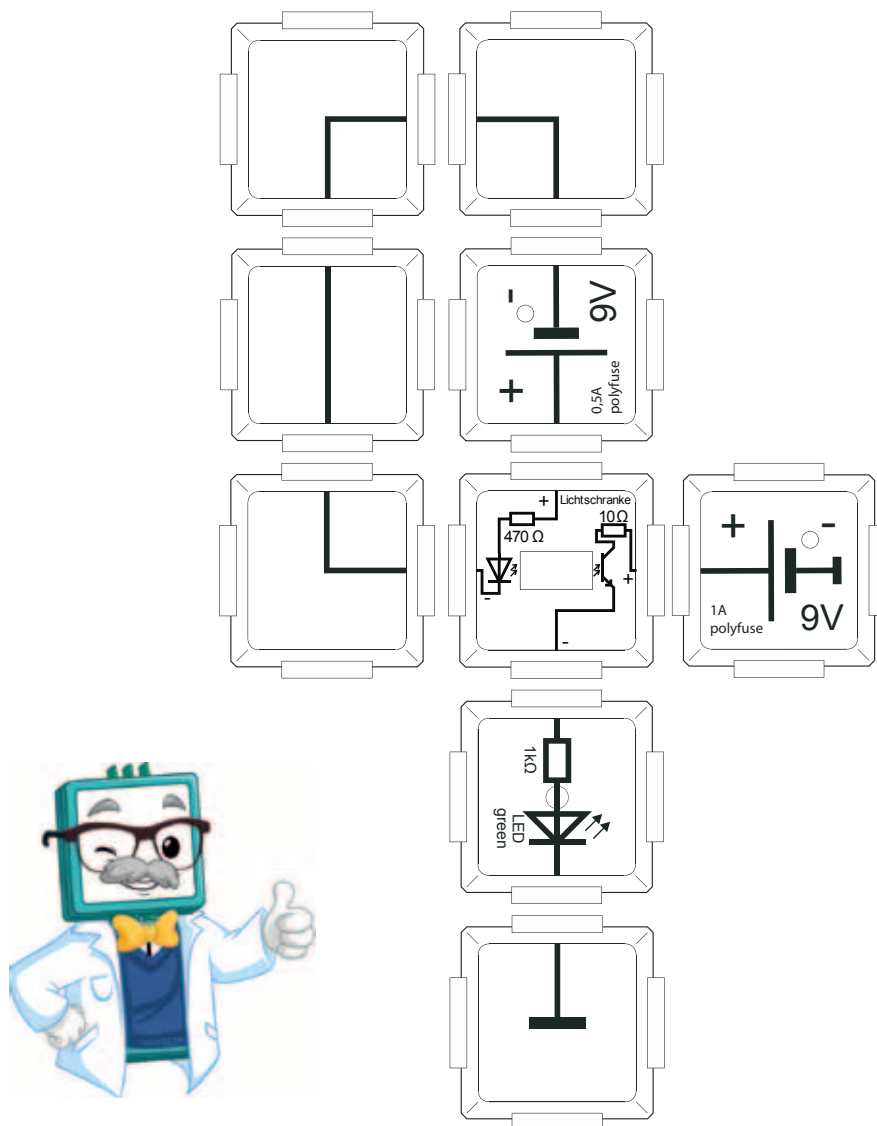

22. Thermo elements

22.1 Thermo elements with PTC

A PTC (Positive Temperature Coefficient) is a resistor that changes its resistance depending on the temperature.

Positive means that the resistive value follows the temperature with a positive sign. The value of the resistor increases when the temperature is rising. Under cold conditions the PTC has a low resistor value. PTCs are often used as protective devices to limit current flow when they get heated up, but also can be used as temperature sensors.

Here the PTC is connected to a potentiometer brick. This allows for an easy adjustment of the trigger threshold of the circuit, because the resistive changes are very low when the temperature changes within the normal room temperature. A MOSFET brick is also connected to the circuit with the base through a 10 k Ohm resistor connected to the wiper contact of the potentiometer brick. The used MOSFET, an n-channel type enhancement, is very sensitive to voltage changes at the gate. With increasing temperature, the drain-source connection starts to conduct and the LED turns on slowly. By adjusting the wiper of the potentiometer, the exact trigger level can be adjusted. Similar to the PTC are classic glow lamps which also conduct at low temperature. The resistance value is increased from several milliohms to more than 1 kOhm after they heat up to 3500 degrees centigrade.

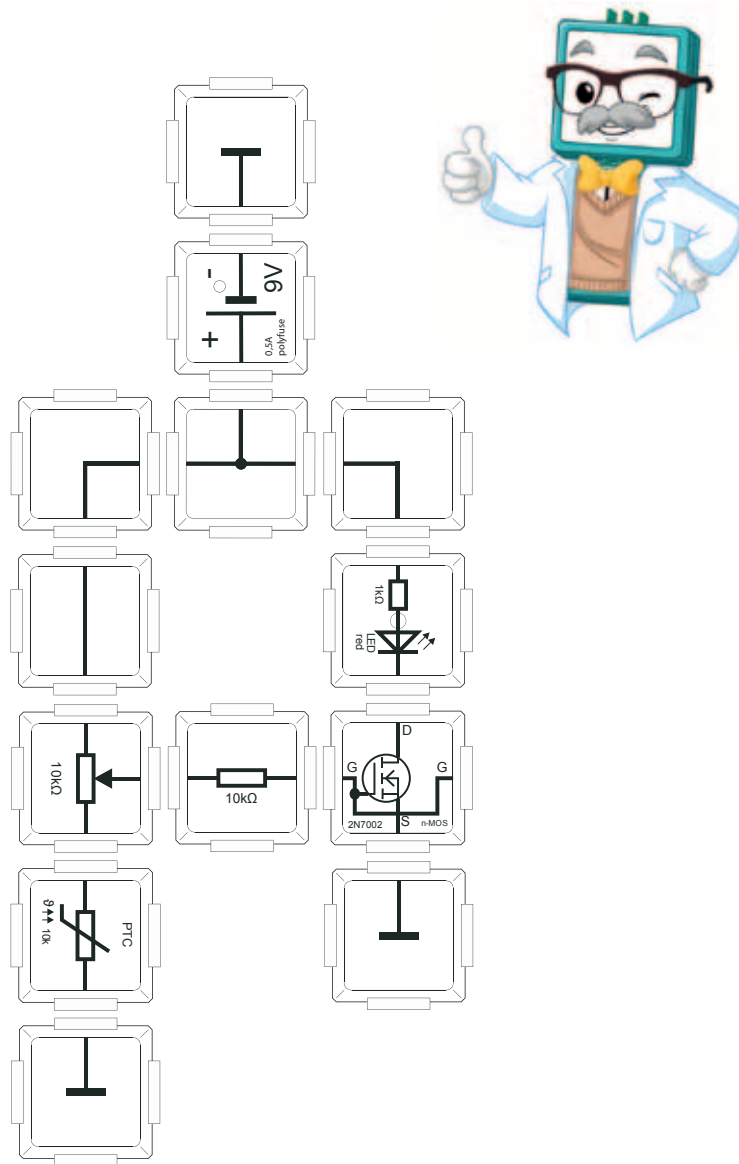

22.2 Thermo elements NTC

An NTC is a temperature-dependent resistor (Negative Temperature Coefficient). Negative in this context means, that resistance and temperature behave inversely proportional to each other. Thus the resistance value decreases with increasing temperature, the component is better conducting when hot than in the cold state.

NTCs are used as temperature sensors. This example circuit brings the NTC in series with the potentiometer in order to adjust the intensity of the blue LED. Blue LEDs have a higher operating voltage than the other LEDs and NTCs and have a relatively high resistance value at room temperature. That's why the circuit can be done without an additional transistor. The LED is connected to the center-tap of the potentiometer. An adjustment of the potentiometer counter clockwise lowers the temperature trigger level.

The function is easy to check with a cold-pack. The colder the NTC-brick gets, the sooner the blue LED turns off if the potentiometer is correctly adjusted for the LED to be on at room temperature. This function can be swapped by exchanging NTC and potentiometer-brick.

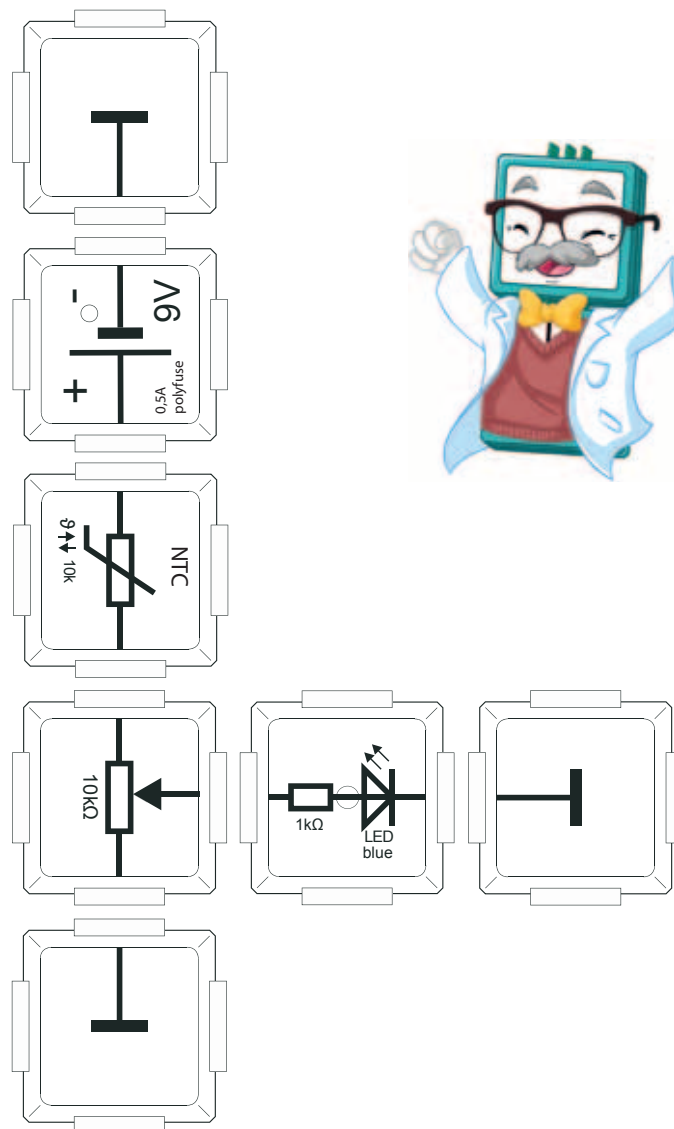

22.3 NTC with MOSFET (n-channel, enhancement mode)

Compared to previous experiments, the MOSFET is now placed between LED and potentiometer-brick. The operation is identical to experiment 22.2, but the transistor makes the circuit just a bit more sensitive, so that the threshold voltage can be adjusted better. The hotter the NTC becomes, the less is the voltage drop. This results in a voltage shift at the output of the voltage divider towards the positive supply and the if the threshold of the MOSFET is exceeded the LEDs turns on.

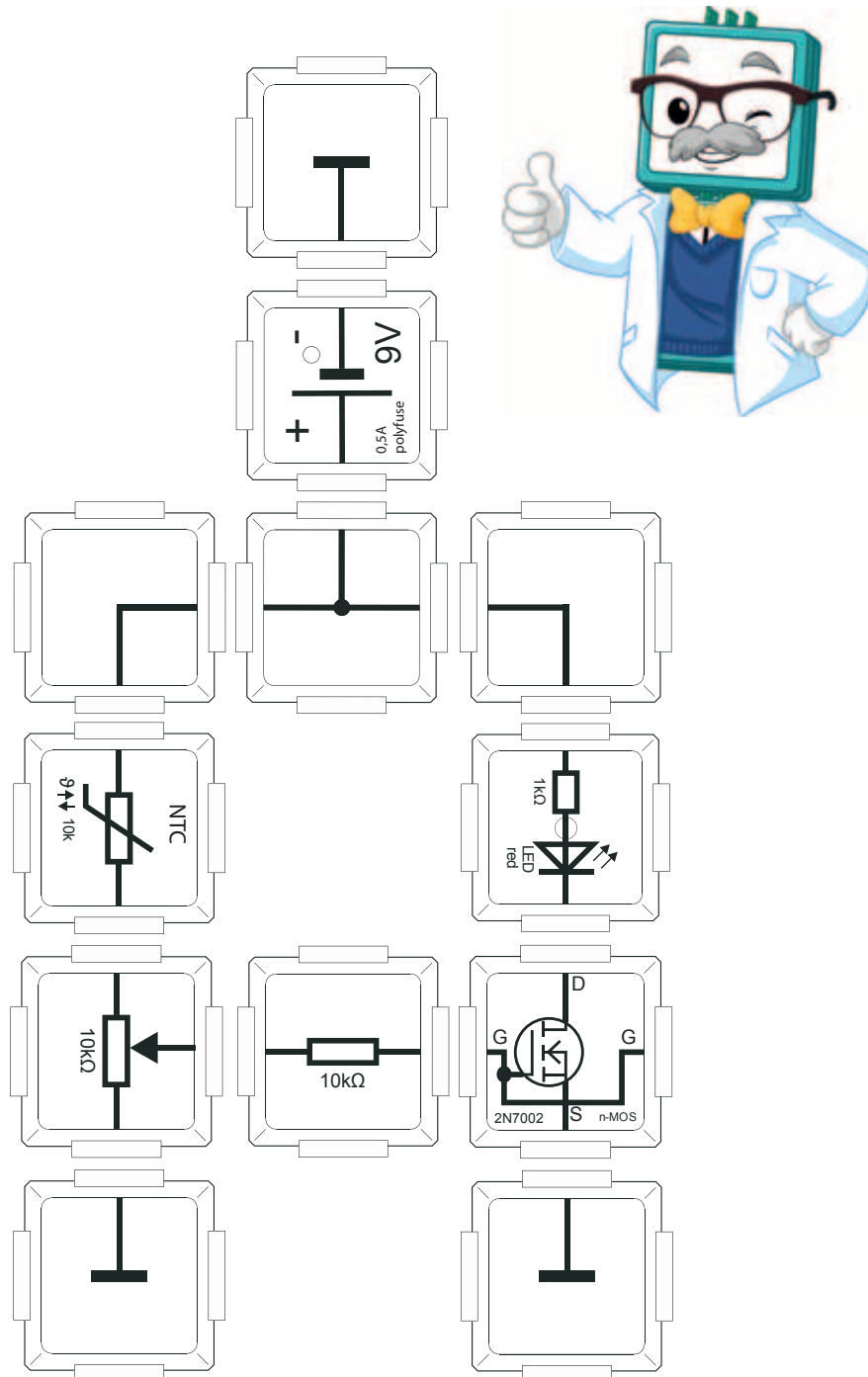

22.4 NTC with a bipolar transistor (BC817)

The experimental setup is very identical to the previous example 22.3. Only the MOSFET-brick has to be replaced by the bipolar BC817-transistor brick. The more the temperature of the NTC rises, the less is the voltage drop. This results in a voltage shift at the output of the voltage divider towards the positive supply and the if the threshold of the transistor of 0.7V at the base is exceeded and enough current flows into the base the LEDs turns on. The resistance value written of the brick is valid at 20°C.

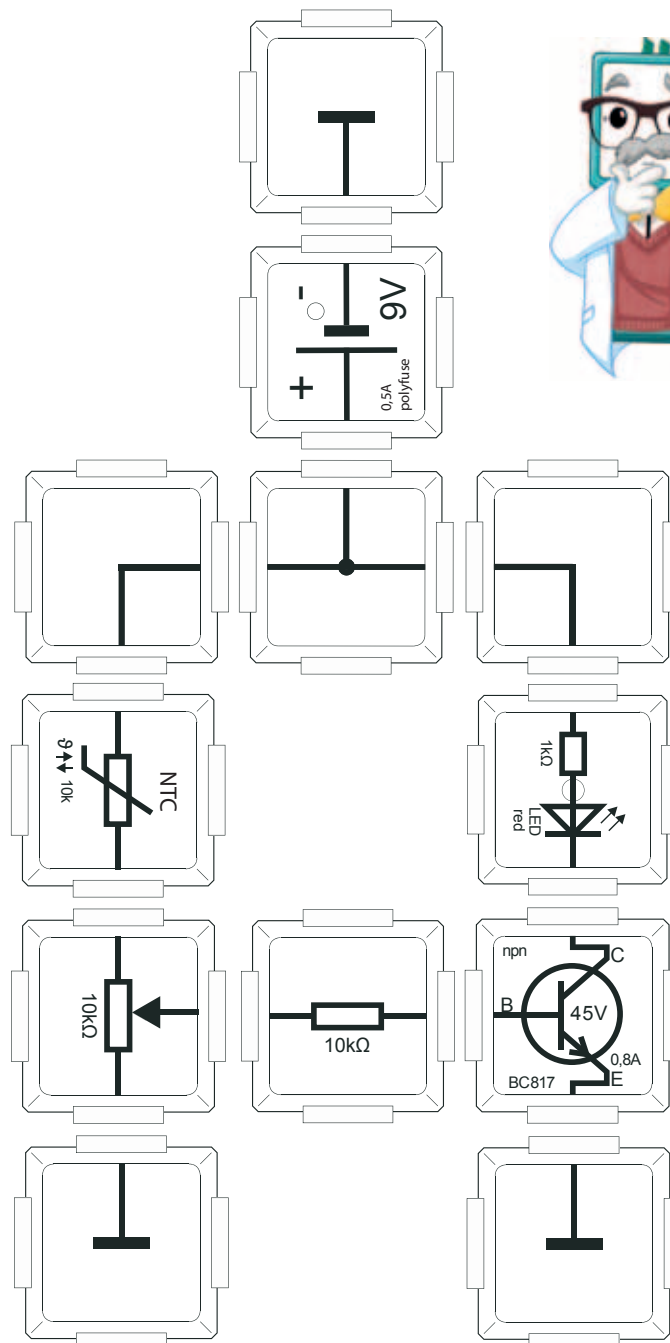

23. A look into the future

Soon, other electronic sets with fascinating possibilities will follow:

- Amateur radio: also suitable for amateur radio exam preparation
- HF technology
- Digital technology
- Modular digital oscilloscope: with 100 MSPS, 2 channels, 14 bit resolution and 2 digital/analog converter 120 MSPS
- Spectrum analyser ca. 200 MHz
- CPU Adapter: for Arduino Nano, Raspberry, BananaPI
- Gigahertz sets
- Signal generator 250kHz-3GHz
- Frequency meter DC-2.5GHz, with additional adapters up to 26GHz
- Other instruments
- I2C modules, empty blocks and other special items converter

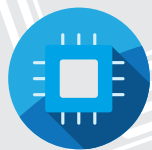

ALLNET GmbH
Maistrasse 2
D-82110 Germering

Tel.: +49 89 894 222-22
Fax.: +49 89 894 222-33

www.brickrknowledge.com
email: info@brickrknowledge.com